



An Overview of Transfer Pricing

Harshal Bhuta

M.Com., F.C.A., A.D.I.T., LL.M. in Intl. Tax Law
(Wirtschaftsuniversität Wien)

Need for Transfer Pricing Regulation



Need for Transfer Pricing Regulations?

❖ Situation before the enactment of Transfer Pricing Regulations

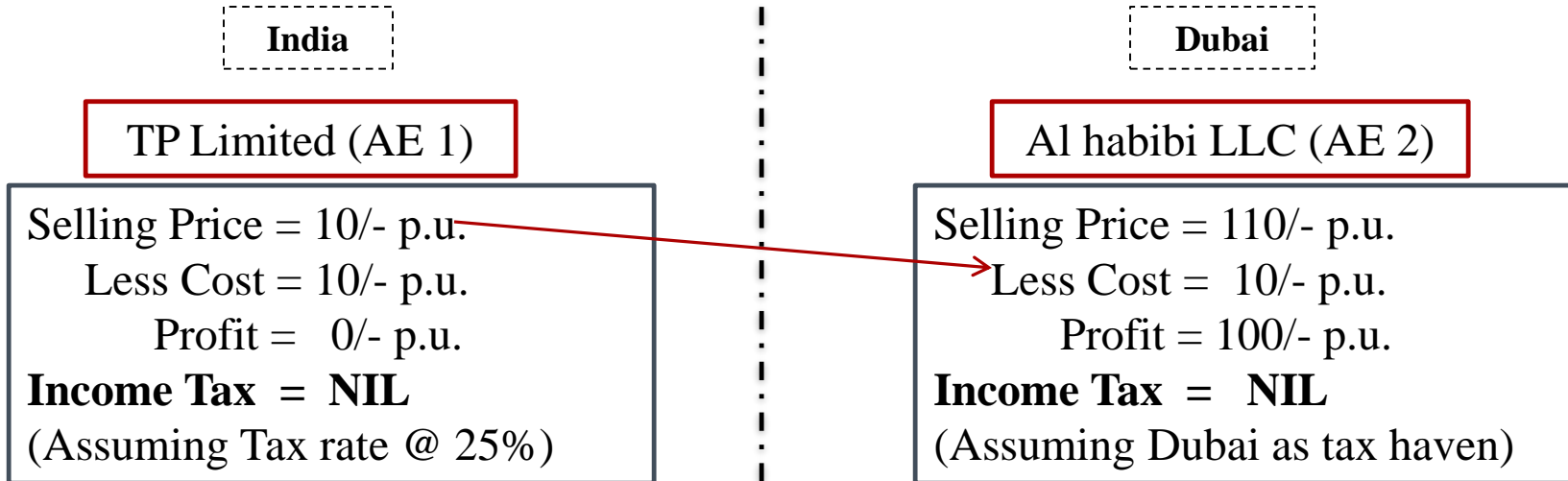

❖ Situation after the enactment of Transfer Pricing Regulations

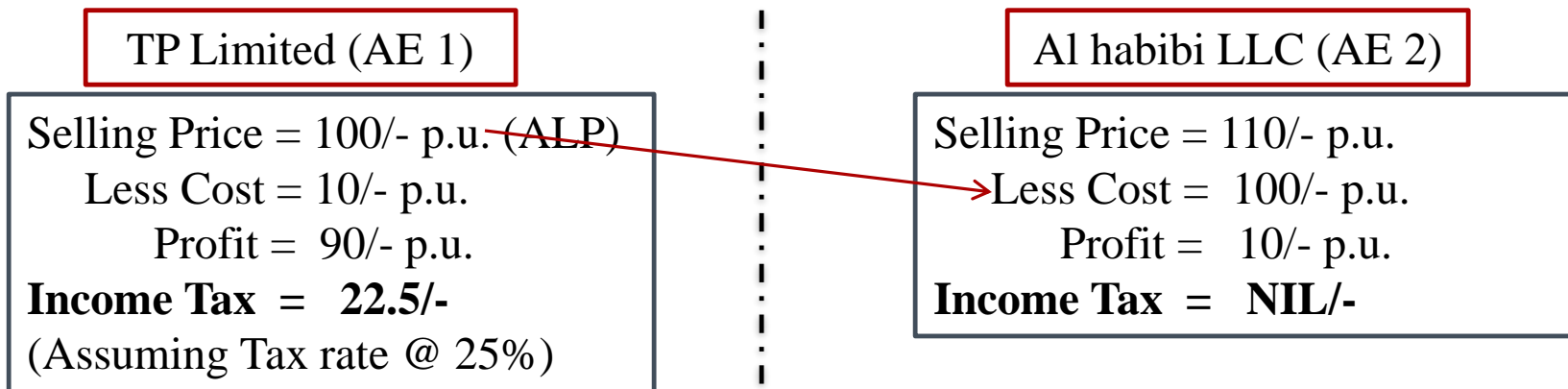

Indian Transfer Pricing Framework

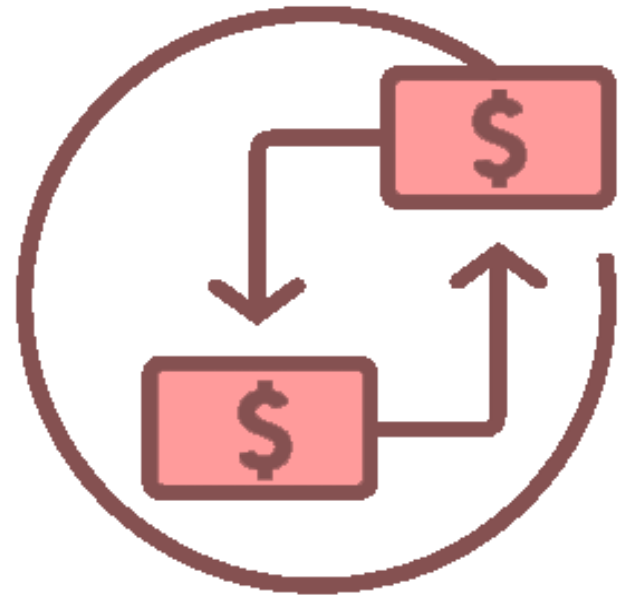

Relevant Regulations

Provision	Section	Rules
Computation of income having regard to ALP	92	---
Meaning of Associated Enterprise	92A	---
Meaning of International transaction	92B	---
Meaning of Specified Domestic Transaction	92BA	---
Methods of computation of ALP *Rule 10AB – Any other method for determination of ALP	92C(1)/ (2)	Rule 10B/10AB/ 10C/10CA
Reference to Transfer Pricing Officer (TPO)	92CA	---
Safe harbour rules	92CB	Rule 10TA to 10TF
Advance Pricing agreement	92CC	Rule 10F to 10T
Effect of advance pricing agreement	92CD	
Secondary Adjustments	92CE	Rule 10CB
Maintenance of information and documents by persons entering into an international transaction or specified domestic transaction (Amended to include requirement of CbCR & Master File)	92D	Rule 10D, Rule 10DA & 10DB
Accountant's Report entering into an international transaction or specified domestic transaction	92E	Rule 10E (Form 3CEB)
Definitions: Accountant, ALP, Enterprise, PE, Specified date, Transaction	92F	Rule 10A

Section 92

- ❖ 92(1) → Any **income, expense or interest** arising from an international transaction or specified domestic transaction shall be computed having regard to arm's length price.
- ❖ Includes -
 - 92(2) → Any cost or expense **allocated or apportioned or contributed under a mutual agreement** to be determined having regard to the ALP of the benefit, service or facility provided under such agreement
 - 92(2A) → Interest or any allowance for expenditure or allocation of cost or expense or income in relation to SDTs
- ❖ 92(3) → This **section does not apply** where it results in reduction of income chargeable to tax or increase in the loss.

Associate Enterprise (AE)



Definition of Enterprise

❖ Defined in Sec. 92F(iii) to mean -

- a person (including a permanent establishment of such person)
- engaged in any specified activity, or in investment, or providing loan or in business of acquiring, holding, underwriting or dealing with securities
- whether such activity or business is carried on, directly or through one or more of its units / divisions / subsidiaries, or
- whether such unit / division / subsidiary is located at the same or at a different place or places

❖ Enterprise vis-à-vis person

Definition of Associate Enterprise

❖ 92A(1) – General conditions

- Direct or indirect participation by an enterprise in management, control or capital of another enterprise.
- Direct or indirect participation by one or more persons in management, control or capital of two enterprises.
- Extent of participation required is not laid down

❖ 92A(2) – Specific conditions

- Deemed AE relationship based on conditions linked to shareholding, board of directors, loans, guarantees, etc.
- “At anytime during the year”

Associate Enterprise

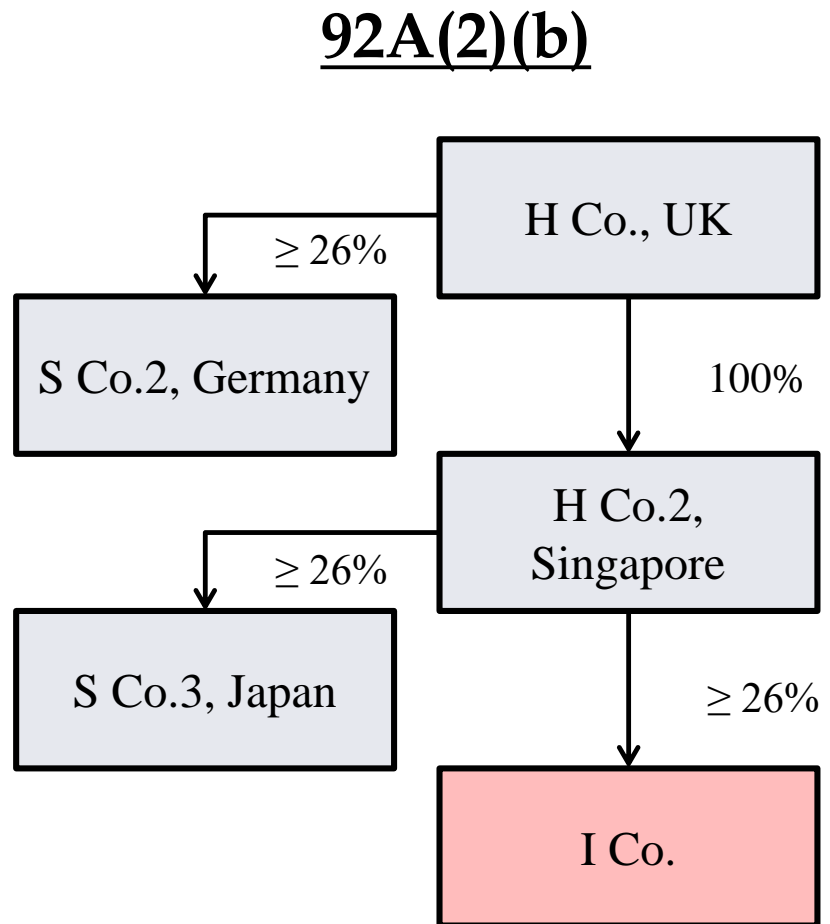
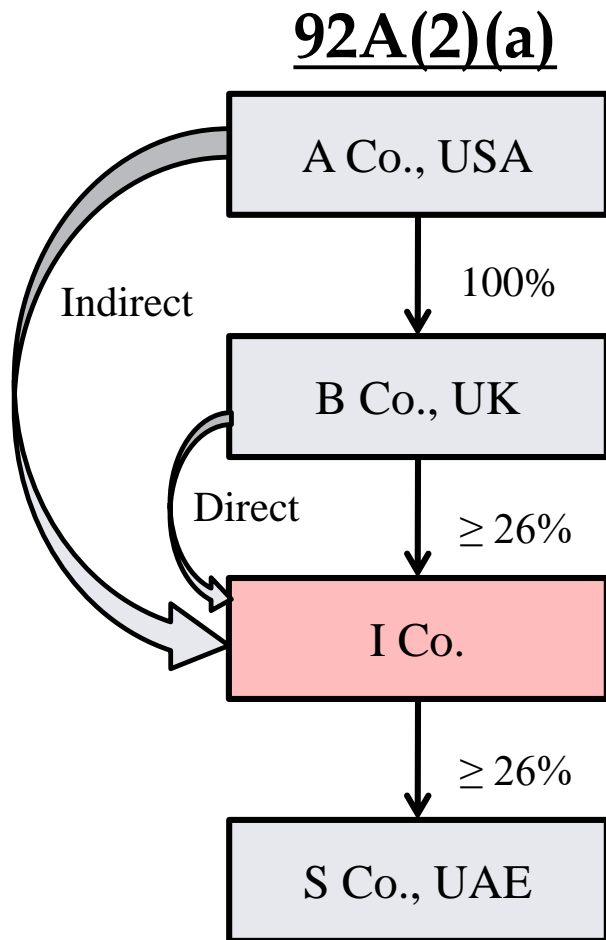

Associate Enterprise

92A(2)(c)

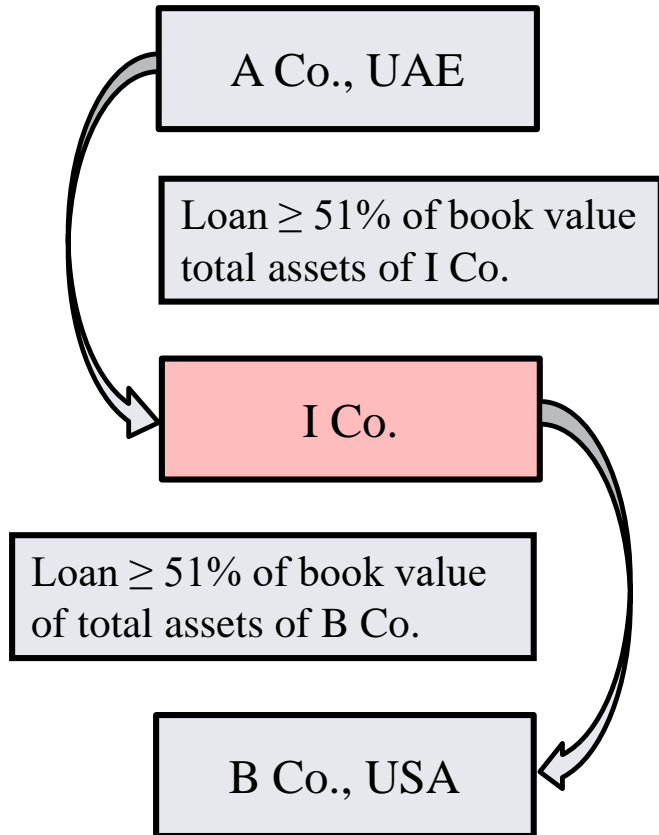

92A(2)(d)

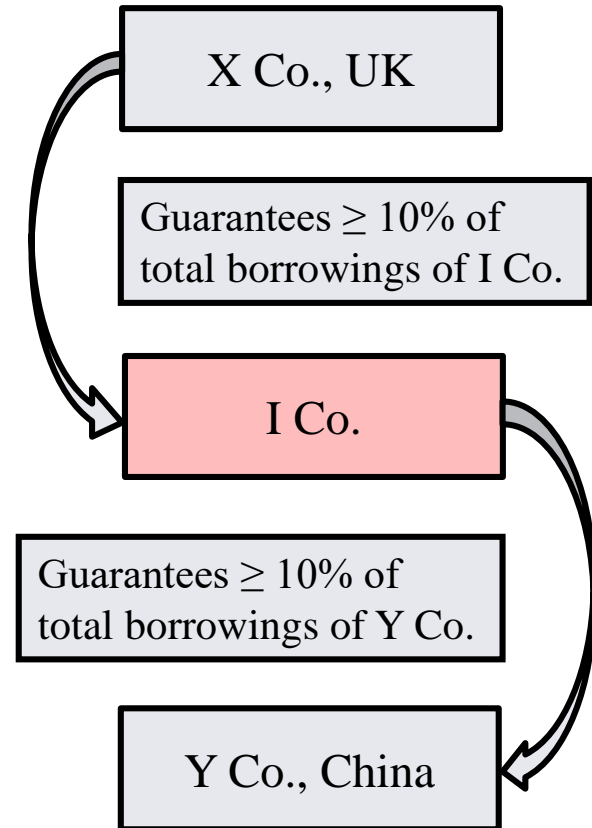

Associate Enterprise

92A(2)(e)

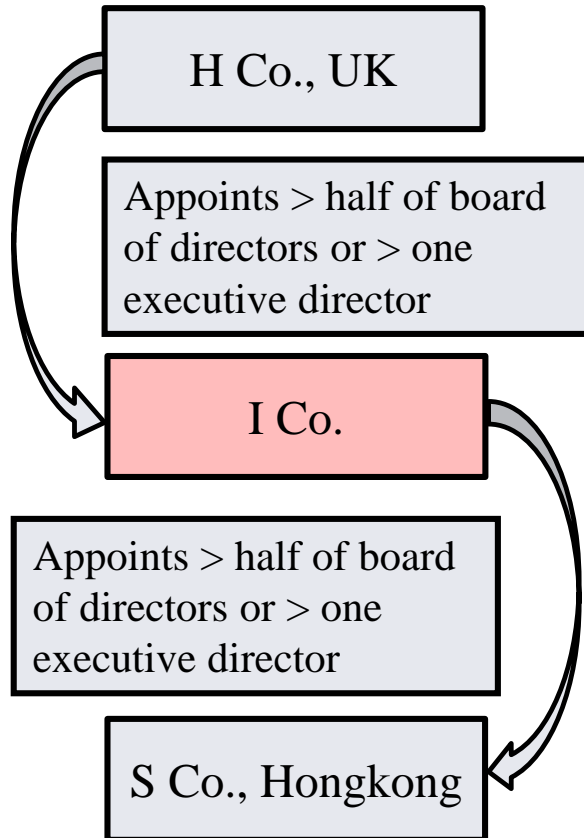

92A(2)(f)

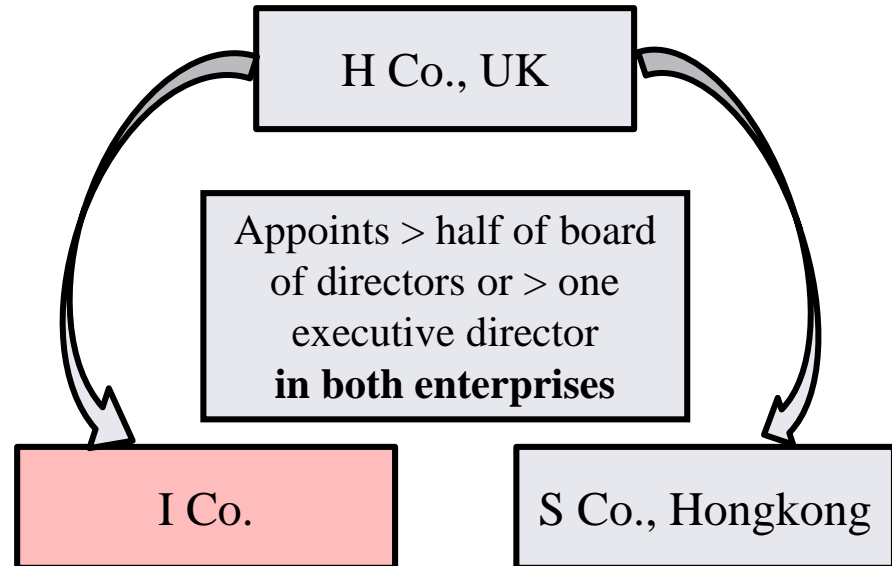

Associate Enterprise

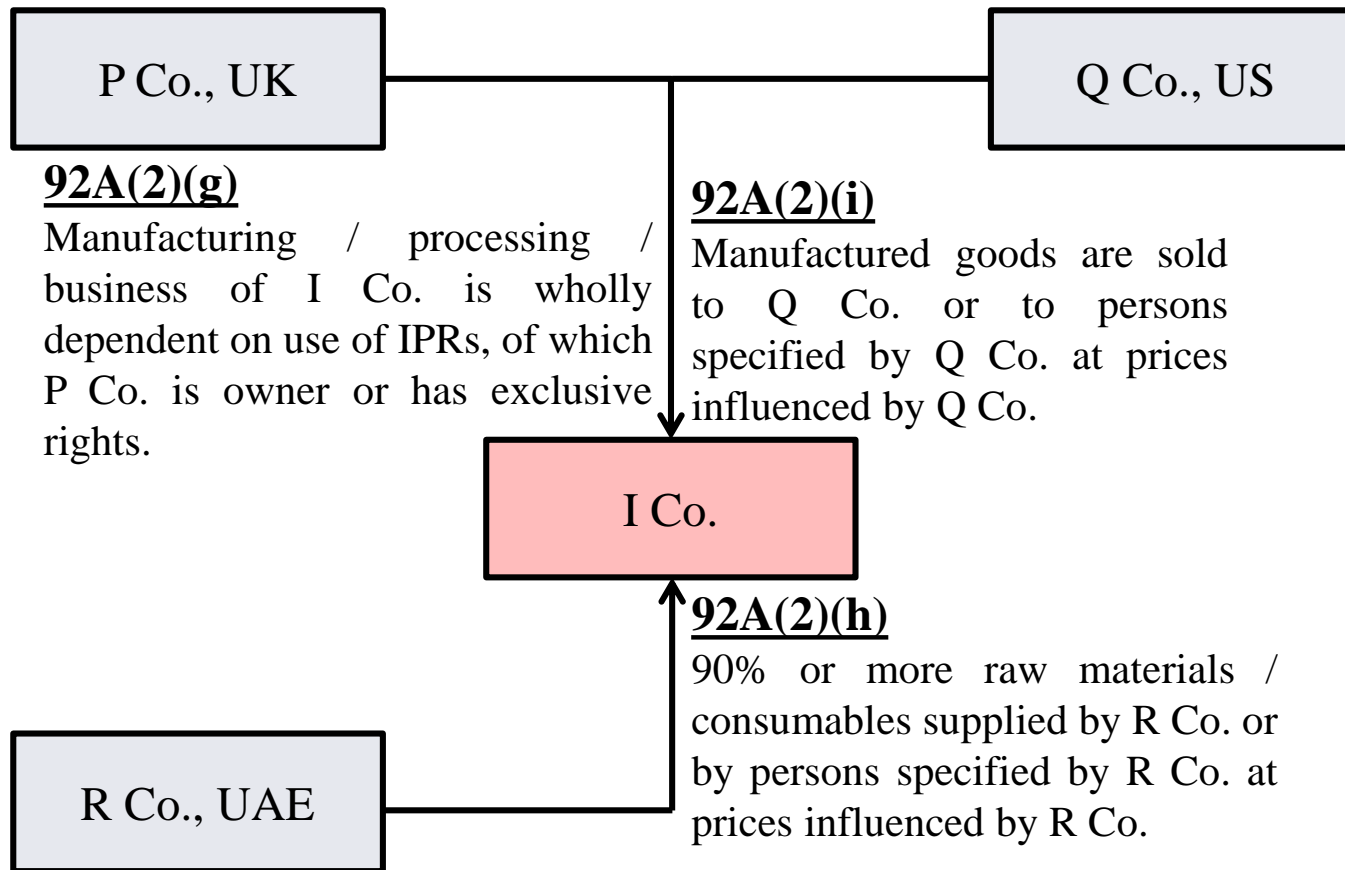

Associate Enterprise

92A(2)(j) & 92A(2)(k)

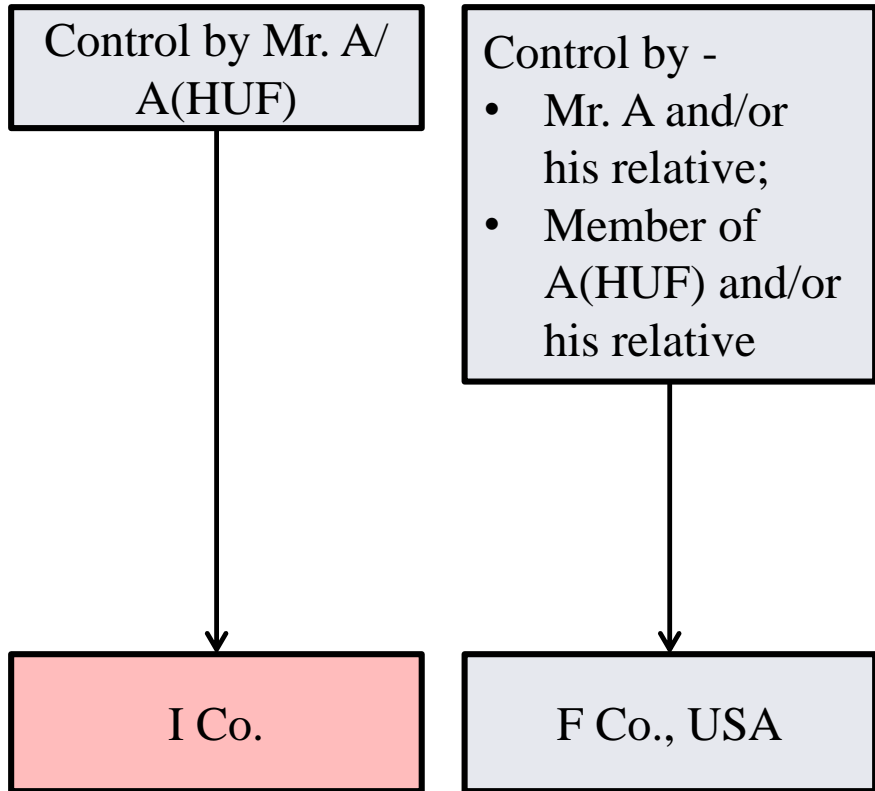

92A(2)(l)

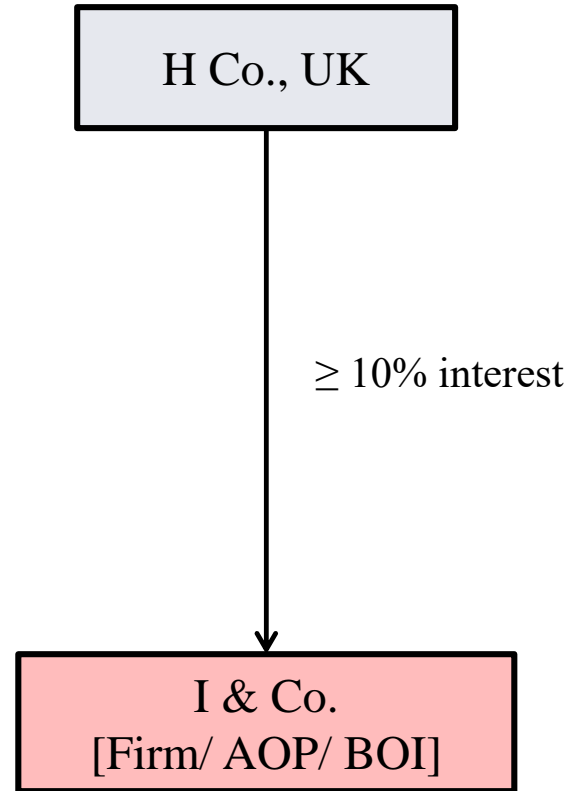

International Transaction (Section 92B)



International Transaction

❖ 92B(1) → International transaction means

- A transaction between two or more AEs, either or both of whom are non-residents,
- In the nature of purchase, sale or lease of tangible or intangible property, or provision of services, or lending or borrowing money, or any other transaction having a bearing on the profits, income, losses or assets of such enterprises
- Includes a cost allocation / apportionment / contribution arrangement

❖ “Transaction” defined in Sec. 92F(v) to include-

- an arrangement, understanding or action in concert,
- whether or not it is in writing,
- whether or not it is intended to be enforceable by legal proceeding

Deemed International Transaction

- ❖ **92B(2) → Transaction with a non-AE deemed to be a transaction between two AEs, if**
 - there exists a prior agreement in relation to the relevant transaction between such other person and the AE, or
 - the terms of the relevant transaction are determined in substance between such other person and the AE
- ❖ **S. 92B(2) deems international transaction without creating deemed AE relationship.**
- ❖ **Transaction between two residents, where –**
 - third party is interposed between two resident AEs
 - third party is interposed between Indian assessee and non-resident AE
 - IJM (India) Infrastructure Ltd. v. ACIT 147 ITD 437 (Hyd. Trib.)

Deemed International Transaction

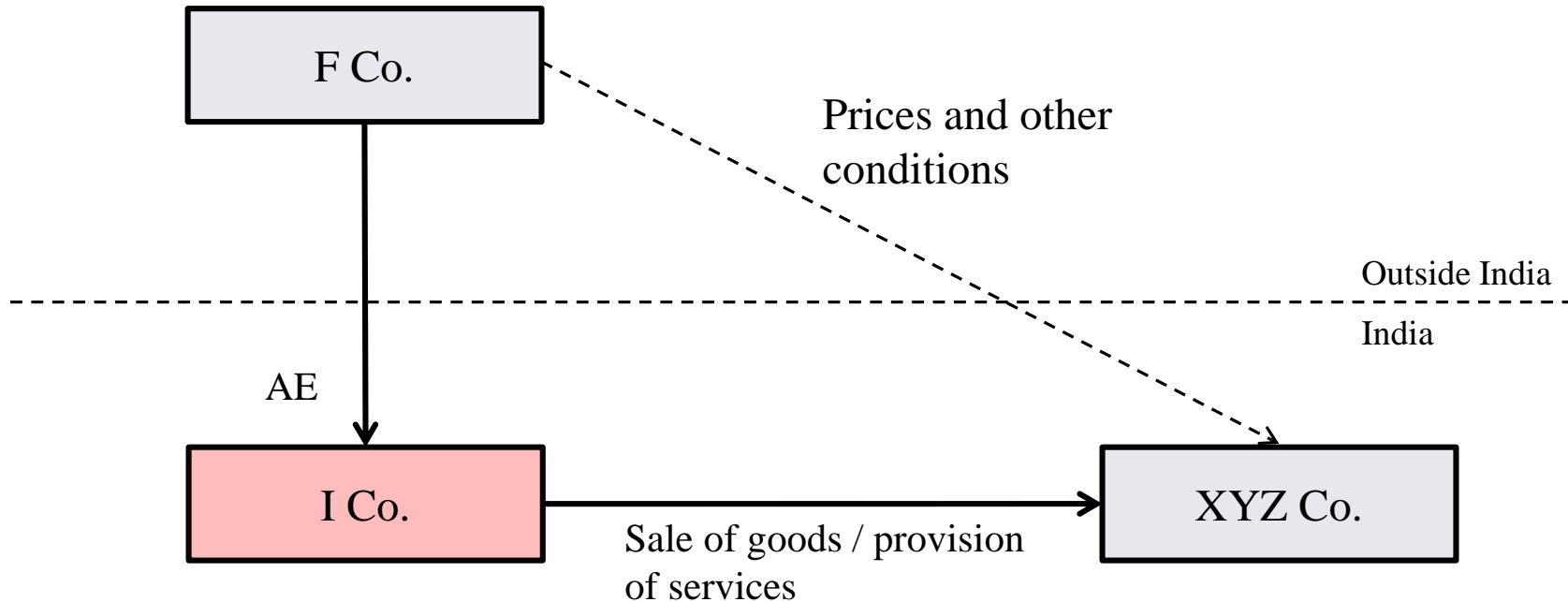

Transaction between I Co. and XYZ Co. is deemed international transaction

Explanation (i) to Section 92B

Clarification to definition of International Transaction

Tangible Property	Intangible Property	Capital Financing	Services	Business restructuring
<ul style="list-style-type: none"> • Purchase, sale, transfer, lease or use of tangible property • Includes building, vehicle, machinery, equipment, plant, furniture, etc. 	<ul style="list-style-type: none"> • Purchase, sale, transfer, lease or use of intangible property • Includes transfer of ownership or the provision of use of rights 	<ul style="list-style-type: none"> • Long-term or short-term borrowing or lending • Guarantee • Purchase or sale of marketable securities • Advance, payments or deferred payment or receivable or any other debt 	<ul style="list-style-type: none"> • Includes market research / development, marketing management • Administration • Technical service • Repairs, design, consultation • Agency • Scientific research • Legal or accounting 	<ul style="list-style-type: none"> • Entered into by an enterprise with an AE • Irrespective of whether it has bearing on the profit, income, losses or assets at the time of the transaction or at any future date

Explanation (ii) to Section 92B

“Intangible Property” to include:

Sr. No.	Intangible Assets	Examples
1	Marketing related	Brand names, Logos, Trade Names, Trade Marks.
2	Technology related	Patent Applications, Process patents, Technical documentation such as laboratory notebooks, Technical know-how.
3	Artistic related	Copyrights, Engravings, Literary works and copyrights, Maps, Musical Compositions.
4	Data Processing related	Automated databases, Integrated circuit masks and masters, Proprietary computer software, Software copyrights
5	Engineering related	Blue prints, Engineering drawing and schematics, Industrial design, Product patents, Proprietary documentation, Trade secrets

Explanation (ii) to Section 92B

Sr. No.	Intangible Assets	Examples
6	Customer related	Customer lists, Customer contacts, Customer relationship, Open purchase orders.
7	Human capital related	Employment agreements, Trained and organised work force, Union contracts.
8	Location related	Air rights, Easements, Leasehold interest, Mineral exploitation rights, Water rights.
9	Goodwill related	Celebrity goodwill, General business going concern value, Institutional goodwill, Personal goodwill of professional, Professional practice goodwill.
10	Methods, systems, procedures, etc.	Campaigns, Customer lists, Estimates, Forecasts, Methods, Procedures, etc.
11	Other similar items	Any other similar items which derives its value from its intellectual content rather than its physical attributes

Prescribed Transfer Pricing Methods



Prescribed Transfer Pricing Methods

- ❖ 92C(1)→ALP to be determined applying any of the following methods, being the most appropriate method:
 - **Comparable uncontrolled price method;**
 - **Resale price method;**
 - **Cost plus method;**
 - **Profit split method;**
 - **Transactional net margin method;**
 - **Other method of determination (Rule 10AB)**
- ❖ 92C(2)→Most appropriate method to be adopted as per Rule 10C. Factors to be considered:
 - Nature and class of transaction
 - Taking into account FAR analysis
 - Availability + reliability of data & accurate adjustments
 - Degree of comparability

Prescribed Transfer Pricing Methods

Comparable Uncontrolled Price ('CUP')	The CUP method compares the price charged in a controlled transaction to the price charged in a comparable uncontrolled transaction in comparable circumstances.
Resale Price Method ('RPM')	The RPM evaluates whether the amount charged in a controlled transaction is arm's length by reference to the gross profit margin realized in comparable uncontrolled transactions.
Cost Plus Method ('CPM')	The CPM method evaluates a controlled transaction by reference to the markup on cost earned in comparable uncontrolled transactions.
Profit Split Method ('PSM')	The PSM allocates operating profits or losses from controlled transactions in proportion to the relative contributions made by each party in creating the combined profits or losses or in proportion to allocation of profits in arm's length transactions.
Transactional Net Margin Method ('TNMM')	The TNMM compares the net profit margin of the assessee arising from a non-arm's length transaction with the net profit margins realized by arm's length parties from similar transactions.
Other Method	Any method that takes in to account the price which has been charged or paid or would have been charged or paid for same or similar uncontrolled transaction with or between non – associated enterprises

Prescribed Transfer Pricing Methods

Case Study – CUP Method

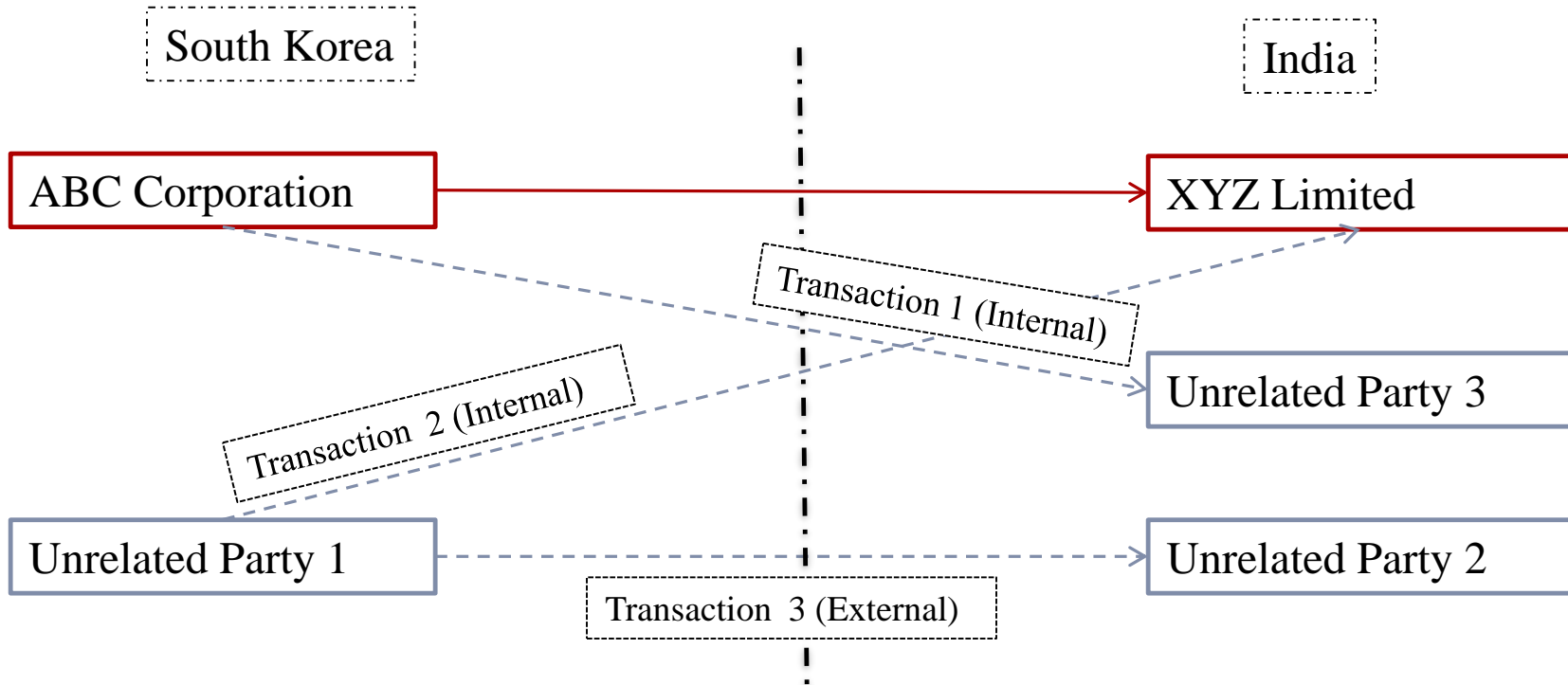

Facts: The controlled transaction in this case involves the transfer of television between ABC Corporation, a television manufacturer in South Korea, and XYZ Limited, a television importer in India. *ABC Corporation is the parent company of XYZ Limited.*

Prescribed Transfer Pricing Methods

Case Study – CUP Method

□ Application of the CUP Method

❖ In applying the CUP method to determine whether the price charged for television transferred in a controlled transaction is at arm's length or not, the following information is assumed to be available for consideration:

- The price charged for television transferred in a comparable uncontrolled transaction between XYZ Limited and Unrelated Party 1; and
- The price charged for television transferred in a comparable uncontrolled transaction between ABC Corporation and Unrelated Party 3; and
- The price paid for television transferred in a comparable uncontrolled transaction between Unrelated Party 1 and Unrelated Party 2.

❖ Analysis:

- Comparison of controlled transaction price with price charged under Transaction 1 / Transaction 2 / Transaction 3 [Mean price under Rule 10CA (7)]

Prescribed Transfer Pricing Methods

Case Study – Resale Price Method

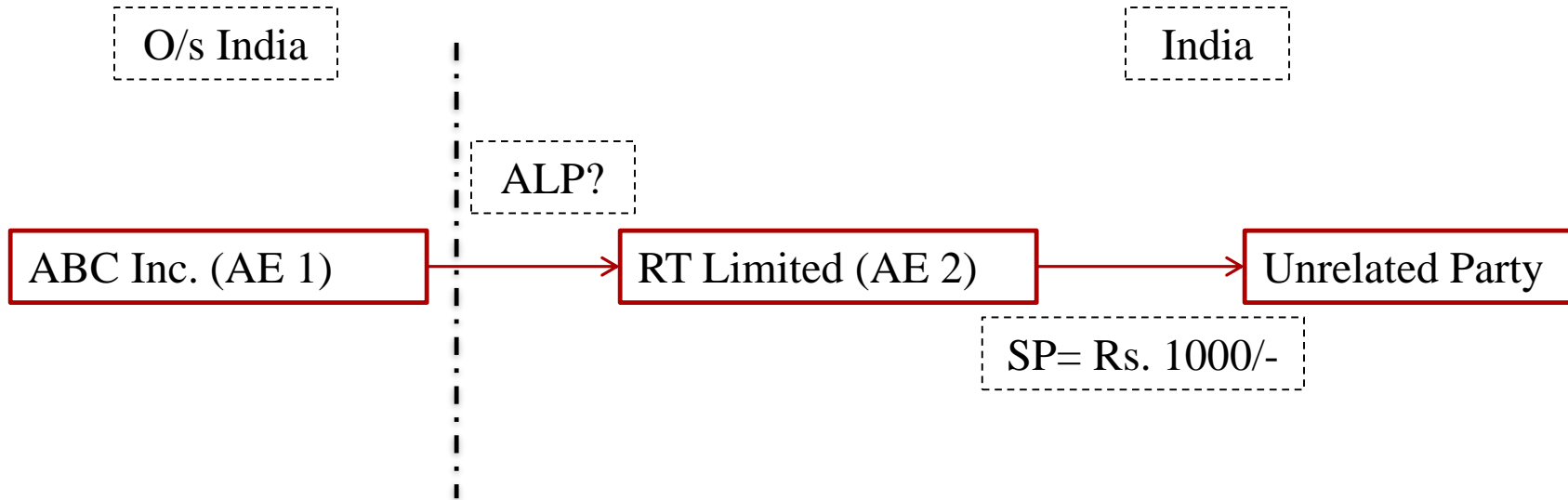

Facts: ABC Inc. is the parent company of the RT Limited. ABC Inc. sells the goods to RT Limited. RT Limited in turn sells the same goods to the unrelated party at the given price of Rs. 1000/-. Assume that a third party distributor competitor earns gross margin of 30% on sales made to unrelated party. Compute the arm's length price for the transaction of the sell of goods between ABC Inc. and RT Limited.

Prescribed Transfer Pricing Methods

Case Study – Resale Price Method

□ Application of the Resale Price Method

- ❖ Under RPM, the transfer price for the sale of goods between ABC Inc. and RT Limited can be described as per the following formula:

$$\text{Transfer Price} = \text{Resale Price} * (1 - \text{Gross Profit Margin})$$

Where,

Resale price means the price at which the goods are sold by RT Limited to unrelated party.

Gross Profit Margin refers to margin earned by competitor when the goods are sold to the unrelated party.

- ❖ Therefore, in this case transfer price (ALP) of transaction of sell of goods between ABC Inc. and RT Limited can be calculated as follows:

$$\text{TP} = \text{Resale Price} * (1 - \text{GPM})$$

$$\therefore \text{TP} = 1000 * (1 - 30\%)$$

$$\therefore \text{TP} = 700/-$$

Prescribed Transfer Pricing Methods

Case Study – Cost Plus Method

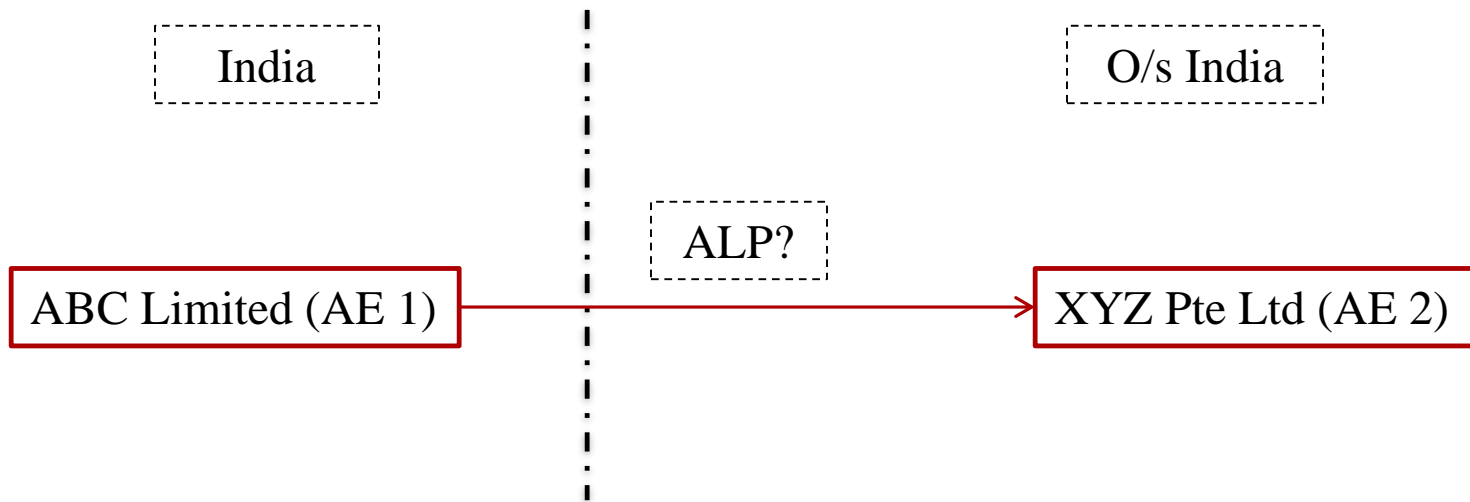

Facts: ABC Limited is the parent company of the XYZ Pte Ltd . ABC Limited sells the goods manufactured by them to XYZ Pte Ltd on a contract basis. Cost of goods sold by ABC Limited to XYZ Pte Ltd is Rs. 1,000/-. Assume that Arm’s length gross profit mark-up that competitor earns is 35%. Compute the arm’s length price for the transaction of the sell of goods between ABC Limited and XYZ Pte Ltd .

Prescribed Transfer Pricing Methods

Case Study – Cost Plus Method

□ Application of the Cost Plus Method

- ❖ Under CPM, the transfer price for the sale of goods between ABC Limited and XYZ Pte Ltd can be described as per the following formula:

$$\text{Transfer Price} = \text{COGS} * (1 + \text{GPM})$$

Where,

COGS refers to the cost of goods sold to the manufacturing company;

- ❖ Therefore, in this case transfer price (arm's length price) of transaction of sale of goods between ABC Limited and XYZ Pte Ltd can be calculated as follows:

$$\text{TP} = \text{COGS} * (1 + \text{GPM})$$

$$\therefore \text{TP} = 1000 * (1 + 35\%)$$

$$\therefore \text{TP} = 1350/-$$

Prescribed Transfer Pricing Methods

Case Study – Profit Split Method

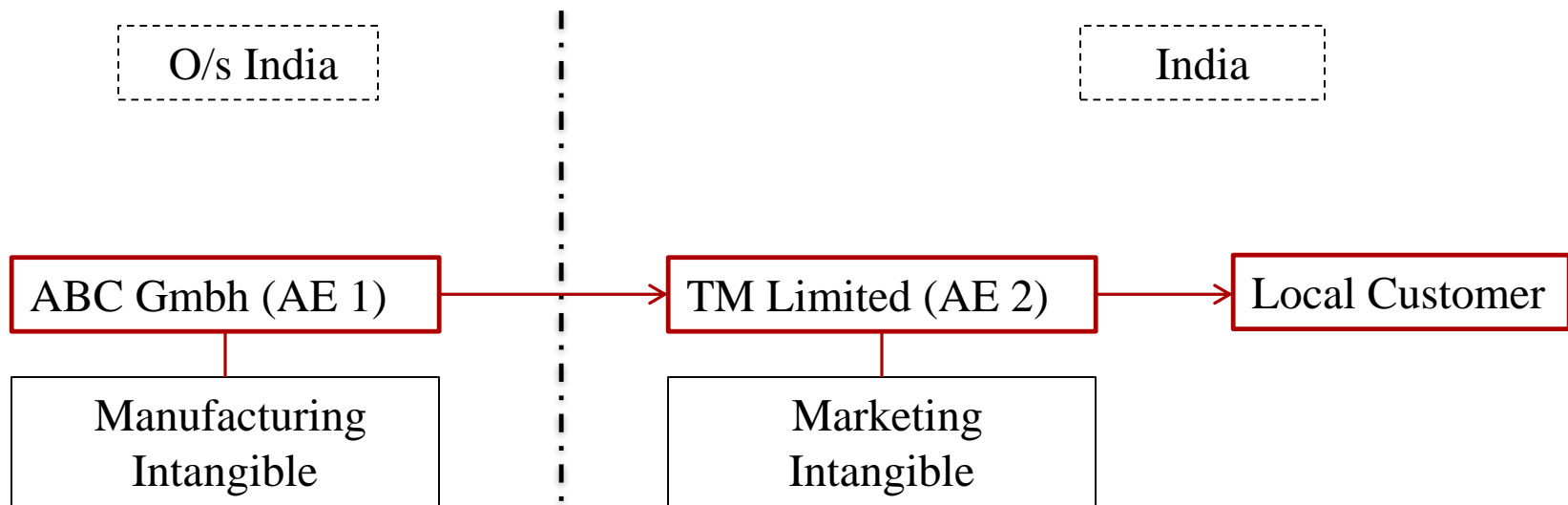

Facts: ABC Gmbh is the parent company of the TM Limited. ABC Gmbh sells high-end cars manufactured by them to their sole distributor TM Limited. ABC Gmbh possesses manufacturing intangibles in the form of secret process for manufacturing, R&D Centre for manufacturing high-end cars. TM Limited performs the distribution function and sells the cars to the local customer in India. TM Limited spends on brand building activities to increase the sale of cars in India. Given data below, compute arm's length profit to be earned by TM Limited.

Prescribed Transfer Pricing Methods

Case Study – Profit Split Method

□ Exhibit of the financial performance of ABC Gmbh & TM Limited

Particulars	ABC Gmbh	TM Limited	Total
Sales	100	160	260
Normal Operating Cost	40	100	140
<i>Expenditure incurred in relation to the unique and valuable intangible</i>	30	20	50
Operating Profit	30	40	70

Prescribed Transfer Pricing Methods

Case Study – Profit Split Method

□ Application of the Profit Split Method

- **Step 1** – Determination of initial return for the non-unique manufacturing/marketing functions.

Assume routine return on manufacturing – 25% on Cost

Assume routine return on Distribution & Sales activity – 5% on sales

Company Name	Particulars (Calculation)	Amount
ABC Gmbh	$(\text{Operating Cost} * 25\%) = (40 * 25\%)$	10
TM Limited	$(\text{Sales amount} * 5\%) = (160 * 5\%)$	8
	Total Profit allocated through initial return	18

Prescribed Transfer Pricing Methods

Case Study – Profit Split Method

□ Application of the Profit Split Method

- **Step 2** – Determination of Residual Profit that needs to be split

Particulars	Amount
Total Operating Profit	70
Profit already allocated in Step 1 (initial return)	18
Residual Profit that needs to be split (proportion of expenditure in relation to the creation of the unique and valuable intangible)	52

Prescribed Transfer Pricing Methods

Case Study – Profit Split Method

□ Application of the Profit Split Method

▪ Step 3 – Allocation of Residual Profit

Company Name	Particulars (Calculation)	Amount
ABC Gmbh	(Residual Profit * Unique Exp. incurred by ABC Gmbh / Total Unique Exp.) = $(52 * 30/50)$	~31
TM Limited	Residual Profit * Unique Exp. incurred by TM Limited / Total Unique Exp.) = $(52 * 20/50)$	~21

□ Total Profits Allocated

Company Name	Particulars (Calculation)	Amount
ABC Gmbh	(Step 1 Amount + Step 3 Amount) = $(10+31)$	41
TM Limited	(Step 1 Amount + Step 3 Amount) = $(8+21)$	29

Prescribed Transfer Pricing Methods

Case Study – Transactional Net Margin Method

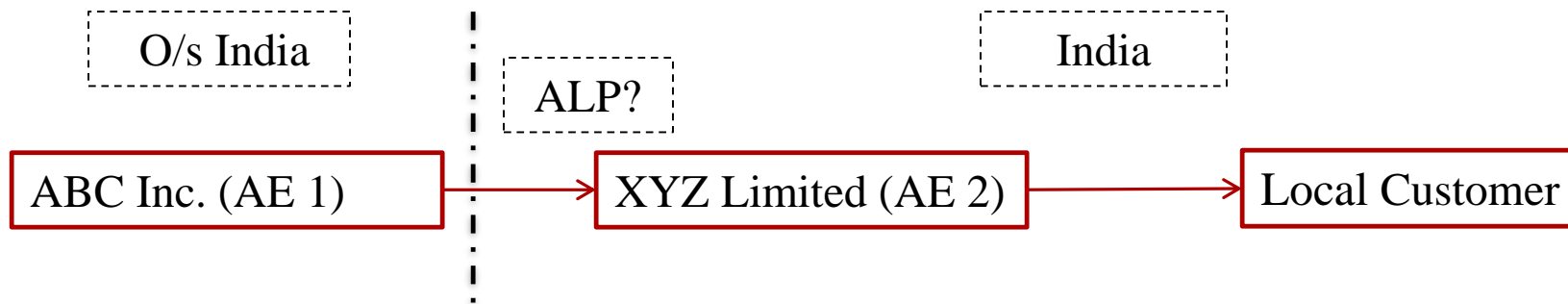

Facts: ABC Inc. is the parent company of XYZ Limited. XYZ Limited purchases raw material from ABC Inc. at a price of Rs. 60/- for manufacturing of goods. Given data below of XYZ Limited, compute the arm's length price for the transaction of the purchase of goods between ABC Inc. and XYZ Limited.

Particulars	Amount
Sales (Local Customer)	100
RM Cost (Pur. From ABC Inc.)	60
Other Operating Cost	30
Operating Profit	10
OPM	10%

Particulars	WAM
35 th Percentile	12%
65 th Percentile	22%
Median of the Dataset	15%

Prescribed Transfer Pricing Methods

Case Study – Transactional Net Margin Method

❑ Application of the Transactional Net Margin Method

- ❖ If the OPM earned in the international transaction is outside the arm's length range then, the arm's length OPM is median of the dataset.
- ❖ Since, the OPM earned by XYZ Limited is 10% which is falling outside the range of OPM earned by comparables in India. Therefore, to compute OPM which XYZ Limited should earn on sales made to local customer, we need to take Median of the dataset viz.15%. Thus, OP that XYZ Limited should earn is Rs.15 (100 * 15%).
- ❖ Computation of Arm's length Raw Material Cost:

Particulars	Amount
Sales	100
Other Operating Cost	30
Operating Profit	15
<i>∴ Arm's Length RM Cost</i>	<i>55</i>
<i>vs. Actual RM Cost</i>	<i>60</i>

Comparability Analysis

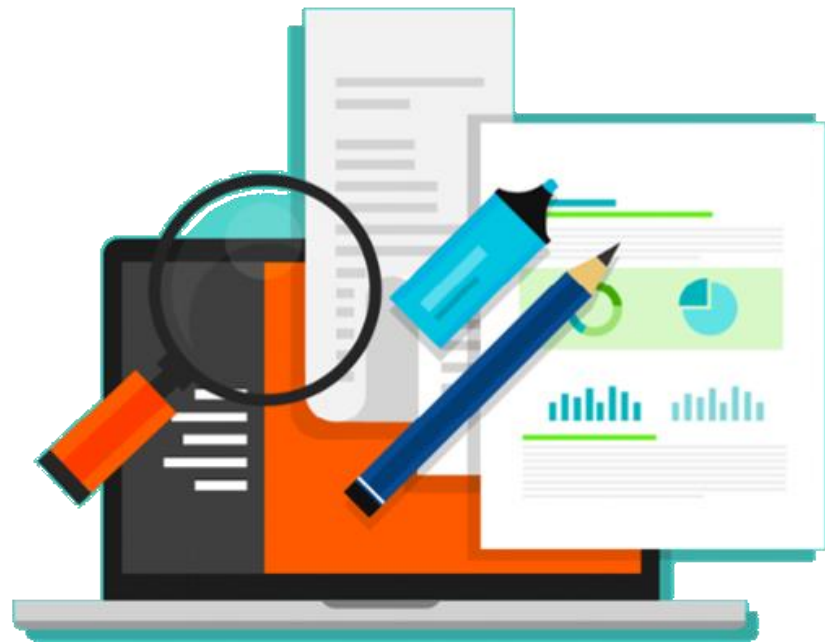

Steps under Comparability Analysis

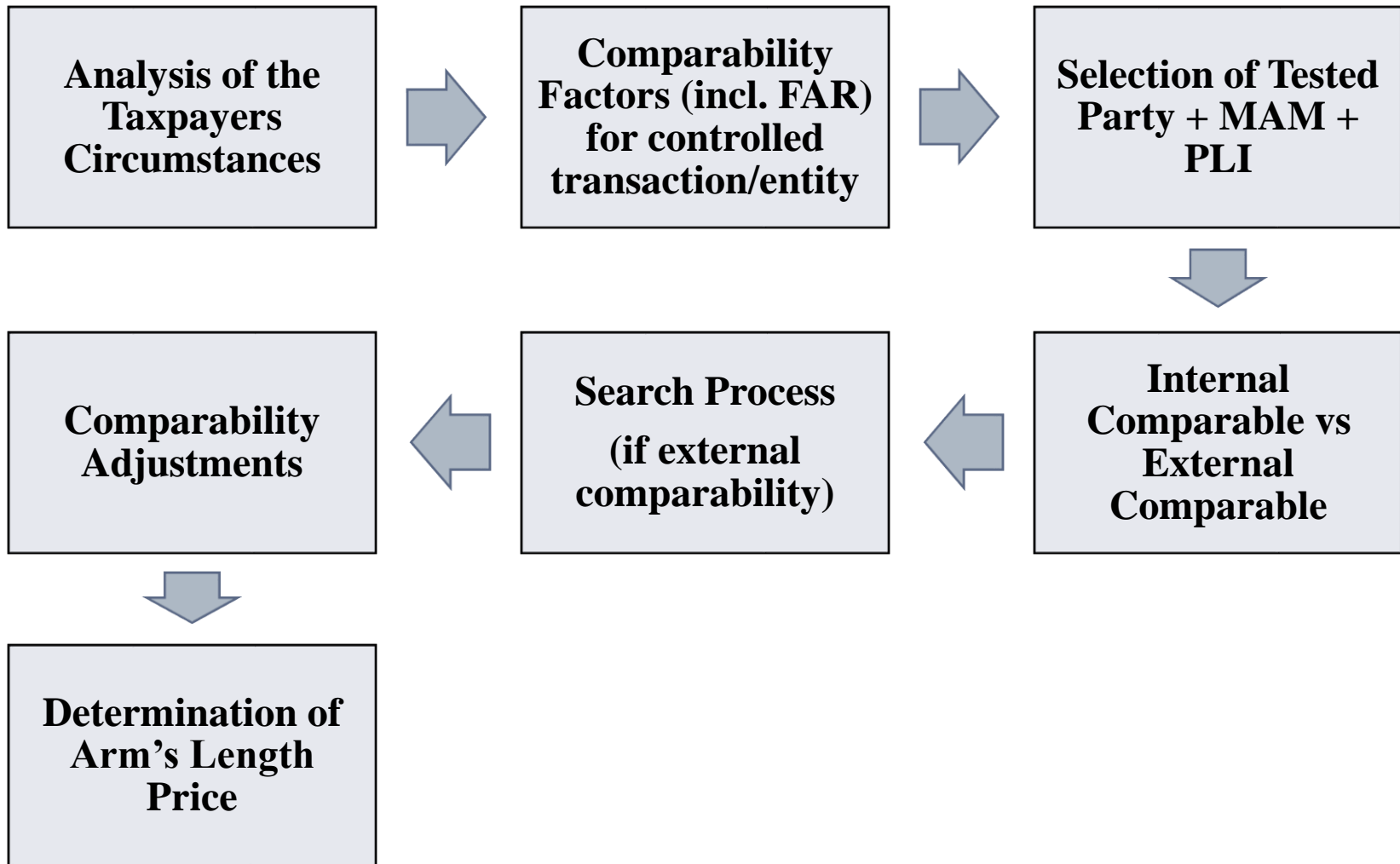

Step 1 – Analysis of Taxpayers Circumstances

- ❖ Collection of information about the taxpayer: Business operations and activities, identification of AEs, information about relevant cross-border controlled transactions, etc.
- ❖ Analysis of industry, competition, economy, regulatory factors affecting taxpayer.
- ❖ Sources of information: Annual report, news articles, research report, management/ internal reports.
- ❖ A study of these documents will provide an idea of:
 - the industry to which the enterprise belongs;
 - the nature of its business activities (i.e. manufacturer, wholesaler, distributor, etc.);
 - its market segment;
 - market share;
 - market penetration strategies;
 - type of products/services dealt in, etc.
- ❖ **Example: Hotel Industry – Various Business Models**

Step 2 – Comparability factors for Controlled Transaction

- ❖ Comparability factors as per Rule 10B(2) of Income Tax Rules, 1962:
 - a. Specific **characteristics of the property or services transferred**;
 - b. **FAR Analysis** of the respective parties to the transactions;
 - c. the **contractual terms of the transactions** which lay down explicitly or implicitly how the responsibilities, risks and benefits are to be divided between the respective parties to the transactions;
 - d. Conditions prevailing in the markets in which the respective parties to the transactions operate, including the geographical location and size of the markets, the laws and Government orders in force, costs of labour and capital in the markets, overall economic development, business cycle and level of competition and whether the markets are wholesale or retail (**Economic Circumstances**).

Step 2 – Comparability factors for Controlled Transaction

❑ **Factor 1: Characteristics of the property transferred or services provided**

❖ Differing characteristics of property / service affects their values in open market. Indicative characteristics listed in UN TP Manual 2021:

- *In case of tangible property:* physical features, quality, reliability, availability and the volume of supply;
- *In case of intangible property:* form of the transaction (e.g. licensing or sale) and the type and form of property, duration and degree of protection and anticipated benefits from use of the property; and
- *In case of services:* nature and extent of such services.

❖ Transactional Analysis - **Separate v/s Aggregation**

- The transfer pricing analysis needs to be made on a transaction-by-transaction basis (*separate*).

Step 2 – Comparability factors for Controlled Transaction

❑ **Factor 1: Characteristics of the property transferred or services provided (Cont.)**

❖ Transactional Analysis - **Separate v/s Aggregation**

- Where transactions are **so closely interrelated** or **continuous** that application of the arm's length principle on a transaction-by-transaction basis would become unreliable or cumbersome, transactions can be often *aggregated*.

❖ Transactional Analysis – **Intentional Set-Offs**

- Intentional set-off typically occurs in a composite transaction when an AE provides a benefit to another AE within the MNC group and is compensated in return by that other enterprise with some other benefit.
- Again, transactions need to be examined separately even though taxpayer may have carried out intentionally set-off.

Step 2 – Comparability factors for Controlled Transaction

❑ **Factor 1: Characteristics of the property transferred or services provided (Cont.)**

Effect of the differences in characteristics on selection of MAM:

a. Price based method (CUP Method):

- Requirement for comparability of property transferred or services is the strictest for the CUP Method and thus, any material difference in the characteristics of property or services can have an effect on the price and would require an appropriate adjustment.

b. Gross profit based methods (CPM/ RPM Method):

- GPM of an entity represents the profits earned by performing core business functions and is not specifically related to the product in which a company deals in. Thus, differences in the characteristics of property or services are less likely to have a material effect.

Step 2 – Comparability factors for Controlled Transaction

❑ **Factor 1: Characteristics of the property transferred or services provided (Cont.)**

Effect of the differences in characteristics on selection of MAM (cont.):

c. Net profit based methods (TNMM):

- Comparability based purely on characteristics of property transferred or services provided becomes even more liberal under TNMM as difference in characteristics are often reflected in variation in operating expenses.
- Thus, comparable uncontrolled transactions need to belong to same genus of products/services but they need not be identical.

Step 2 – Comparability factors for Controlled Transaction

❑ Factor 2 : FAR Analysis

Purpose of FAR Analysis:

- ❖ As per economic theory, the more valuable the functions performed, assets employed and the greater the risks assumed by a party to a transaction the greater its expected return (or potential loss).
- ❖ Comparison of only economically significant FAR
- ❖ This analysis helps to select
 - the tested parties;
 - the most appropriate method (MAM);
 - the comparables; and
 - eventually to determine whether the profits/ losses earned by the entities are appropriate to the functions performed, assets employed and risks assumed.

Step 2 – Comparability factors for Controlled Transaction

❑ Factor 2 : FAR Analysis

Why to do FAR Analysis? – MAM

Section 92C - The arm's length price in relation to an international transaction shall be determined by any of the following methods, being the most appropriate method, having regard to the nature of transaction or class of transaction or class of associated persons or **functions performed** by such persons or such other relevant factors”

Rule 10C(2) - “In selecting the most appropriate method, the following factors shall be taken into account, namely:

(b) the class or classes of AEs entering into the transaction and the **functions performed** by them taking into account **assets employed** or to be employed and **risks assumed** by such enterprises”

Step 2 – Comparability factors for Controlled Transaction

❑ Factor 2 : FAR Analysis

Why to do FAR Analysis? – Selection of Comparables & Documentation

Rule 10B(2) - Comparability of an international transaction with an uncontrolled transaction shall be judged with reference to (among others):

- **Functions performed**, taking into account **assets employed** and **risks assumed**, by both the parties to the transactions

Rule 10D(1) – Documentation

“(e) a description of the **functions performed, risks assumed** and **assets employed** or to be employed by the assessee and by the associated enterprises involved in the international transaction”

Step 2 – Comparability factors for Controlled Transaction

❑ **Factor 2 : FAR Analysis**

Components of FAR Analysis:

❖ **Functions performed:**

- Functions performed are the activities that are carried out by each of the parties to the transaction.
- Some of the important functions: R&D, warehousing and inventory, marketing and distribution, manufacturing etc.

❖ **Assets employed:**

- The type and nature of assets used (tangible/ intangible) in the course of controlled transaction needs to be identified.
- It is essential to know which entity has developed the intangibles, who has the legal ownership of such intangibles & who enjoys the benefits of the intangibles.

Step 2 – Comparability factors for Controlled Transaction

❑ Factor 2 : FAR Analysis

Components of FAR Analysis:

❖ Risks assumed:

- Risk study includes identification of various risks that are assumed by each of the parties to the transaction.
- Some of the significant risks: product liability risk, design and development of product risk, market risk, inventory risk, credit risk, obsolescence risk.
- Ascertainment of parties who have control over risk and financial capacity to assume risk gains importance over contractual allocation of risks.

Step 2 – Comparability factors for Controlled Transaction

❑ Factor 2 : FAR Analysis

Effects of FAR Analysis on the selection of the MAM:

- a. **CUP Method:** Similarity in characteristics of the property transferred or service provided is of utmost importance rather than FAR Analysis.
- b. **RPM/ CPM Method:** Similarity in functions, assets and risks becomes important as gross profit is driven more by functions performed and less by nature of products being transferred.
- c. **TNMM:** Broad similarity in the FAR is desirable since net profit indicators are less adversely affected by differences in FAR.
- d. **PSM:** Under PSM, combined profits are allocated on the basis of their relative contribution and this relative contribution is in turn measured in terms of FAR of each such entity. Hence, FAR analysis becomes critical.

Step 2 – Comparability factors for Controlled Transaction

Typical FAR of Manufacturers

Particulars	Full Fledged Manufacturer	Contract Manufacturer	Toll Manufacturer
Functions Performed			
R&D	Significant	-	-
RM Procurement	Significant	Moderate	-
Manufacturing	Significant	Significant	Significant
Inventory Mgmt.	Significant	High	-
Marketing	Significant	-	-
Assets Employed			
Intellectual Property	Significant	-	-
Tangible Property	Significant	Significant	Significant
Risks Assumed			
Market risk	Significant	-	-
Inventory risk	Significant	High	-

Step 2 – Comparability factors for Controlled Transaction

Typical FAR of Manufacturers

Particulars	Full Fledged Manufacturer	Contract Manufacturer	Toll Manufacturer
Product Liability risk	Significant	-	-
Credit risk	Significant	Moderate	-
Warranty risk	Significant	Significant	Moderate

❖ Indicators to evaluate FAR of comparables (Manufacturers)

- Manufacturing Sales / Sales
- R&D Expense / Sales
- Marketing Expense / Sales
- Plant & Machinery / Total Assets
- Inventory / Sales
- Royalty Expense / Sales
- Intangible Assets / Total Assets
- Raw Material / Total Cost

Step 2 – Comparability factors for Controlled Transaction

Typical FAR of Distributors

Particulars	Distributor	Buy-sell Distributor
Functions Performed		
Warehousing and Inventory Mgmt.	Significant	Low
Sale and Distribution support	Significant	Moderate
After sales services	Significant	Significant
Strategic marketing	Moderate	-
Assets Employed		
Warehouse/Other Tangible Asset	Significant	Significant
Customer List (Asset)	Significant	Low
Risks Assumed		
Market risk	Significant	Low
Inventory risk	Significant	Low
Obsolescence risk	Significant	-

Step 2 – Comparability factors for Controlled Transaction

Typical FAR of Distributors

Particulars	Distributor	Buy-sell Distributor
Freight risk	Significant	Moderate
Credit risk	Significant	Low
Foreign Exchange risk	Significant	Moderate

❖ Indicators to evaluate FAR of comparables (Distributors)

- Plant & Machinery / Total Assets
- Advertising Expense / Sales
- Purchase Cost / Total Cost
- Inventory / Sales

Step 2 – Comparability factors for Controlled Transaction

Typical FAR of Service Provider

Functions/ Assets/ Risks	Entrepreneur	Low risk/Captive service provider
Functions Performed		
R&D	Significant	-
Quality Assurance	Significant	Moderate
Human resource	Significant	High
Marketing	Significant	-
Assets Employed		
Intellectual property	Significant	-
Human resource intangible	Significant	-
Risks Assumed		
Human resource attrition risk	Significant	Significant
Service liability risk	Significant	Moderate

Step 2 – Comparability factors for Controlled Transaction

Typical FAR of Service Provider

Functions/ Assets/ Risks	Entrepreneur	Low risk/Captive service provider
Capacity utilization risk	Significant	-
Regulatory risk	Significant	Significant
Credit risk	Significant	-

❖ Indicators to evaluate FAR of comparables (Service Providers)

- Employee Cost / Sales
- R&D Expense / Sales
- Intangible Assets / Total Assets
- RPT / Sales

Step 2 – Comparability factors for Controlled Transaction

❑ Factor 3 : Review of Contractual Arrangements

- Relevance of contractual arrangements:

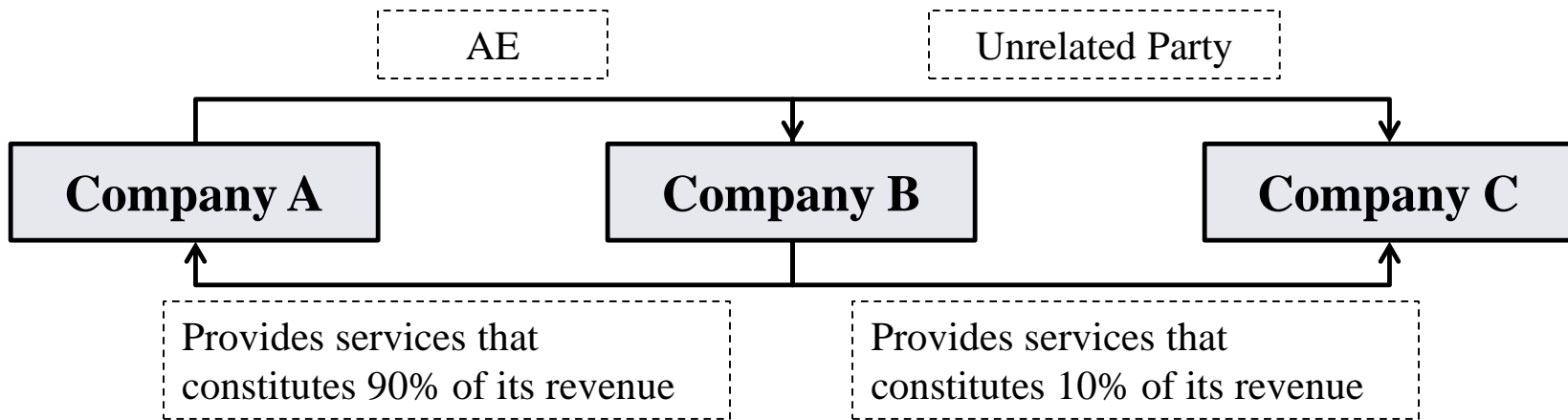

In determining the degree of comparability between Company B's uncontrolled transaction with Company C and its controlled transaction with Company A, the difference in volumes involved in the two transactions, volume discount if any, and the regularity with which these services are provided must be taken into account where such factors would have a material effect on the price charged.

Step 2 – Comparability factors for Controlled Transaction

❑ **Factor 3 : Review of Contractual Arrangements**

Effects of contractual arrangements on the selection of the MAM:

- a. Price based methods (CUP):** Differences in contractual terms of the transaction have a bigger impact as compared to profit based methods. For e.g. Similarity in the credit terms offered under controlled and the uncontrolled transaction need to be examined to determine comparability between controlled and uncontrolled transaction.
- b. Profit based methods (CPM/ RPM/ TNMM):** Effect of differences in contractual terms may get evened out under profit based method and thus such differences may not affect selection of profit based methods.

Step 2 – Comparability factors for Controlled Transaction

❑ Factor 4 : Economic Circumstances

- ❖ Geographical Location
- ❖ Size of the Market and Level of Competition
- ❖ Nature of Market – Wholesale or Retail
- ❖ Laws and Government orders in force
- ❖ Cost of Labour and Capital
- ❖ Overall Economic Development
- ❖ Existence of Business Cycle

Step 2 – Comparability factors for Controlled Transaction

❑ Factor 4 : Economic Circumstances

Geographical Location

Location Savings

- ❖ Net ‘Cost savings’ realized by an MNC as a result of relocating manufacturing functions/ production/ operation sites from a ‘high cost’ to ‘low cost’ jurisdiction to obtain competitive advantage.
- ❖ Typical cost savings include savings pertaining to:
 - Labour costs;
 - Raw material costs;
 - Rent and property taxes;
 - Training costs;
 - Infrastructure costs and
 - Incentives including tax exemptions
- ❖ Most low cost locations are in the ‘Developing World’ (example- India, China, Indonesia, Vietnam etc.)

Step 2 – Comparability factors for Controlled Transaction

❑ Factor 4 : Economic Circumstances

Geographical Location

Location Savings (cont.)

Location savings = Input cost in a high cost region – Input cost in a low cost region

Net Location savings = Cost Savings – Dissavings

Location Specific Advantage (LSA) = Net Location savings +/- Other location specific benefits

LSA >= Location Rent

- Issue → ALP attribution of Location Rent
- Country Practice - India (Para D.3.8)

Step 2 – Comparability factors for Controlled Transaction

❑ Factor 4 : Economic Circumstances

Size of the Market and Level of Competition

- Size of market and level of competition have an effect on transaction prices.
- Pricing strategies of an enterprise may depend upon size of market and its market share therein.
- Similarly, pricing strategy also depends upon level of competition in the market.

Nature of market – whether wholesale or retail

- Nature of market plays a big role in profit earning capacity of an enterprise.

Laws and Government orders in force

- The government policies and regulations also have a considerable impact on the prices and margins of the enterprise. For e.g. Price control in pharma industry.

Step 2 – Comparability factors for Controlled Transaction

❑ Factor 4 : Economic Circumstances

Cost of Labour and Capital

- The price in any particular transaction is a function of its cost and since the cost of labour and capital vary from market to market, so does the consequential price earned by the enterprise.

Overall Economic Development

- The overall state of the economy in terms of its level of development also needs to be considered in the comparability analysis.

Existence of Business cycle

- Whether the economy is in boom or recession would impact the selection of comparables.

Step 3 – Selection of Tested Party

- ❖ For CPM, RPM and TNMM, it is necessary to choose the party to the transaction for which a financial indicator (GPM, NPM) is tested.
- ❖ FAR analysis would typically guide in choosing the tested party
- ❖ Characteristics of Tested Party
 - The tested party should be *least complex* among the parties to the transaction.
 - The tested party should be the one for which *reliable and accurate data* is available.
 - The tested party should be the one which requires *least adjustments* in order to make it comparable.
- ❖ Tested Party – Indian or Foreign ?

Step 3 – Selection of MAM/ PLI

- ❖ There is no priority in selection of transfer pricing method. Instead, the method which is best suited to facts and circumstances of each transaction should be chosen as MAM.
- ❖ Rule 10C mentions following factors for selection of MAM:
 - Nature and class of transaction
 - Class of AE entering into transaction and FAR of such enterprise
 - Availability, coverage and reliability of data
 - Degree of comparability
 - Extent to which reliable and accurate adjustment can be made
 - Nature, extent and reliability of assumption required to be made

Step 4 – Internal vs. External Comparable

❖ Comparable uncontrolled transactions (“Comparables”) can be of 2 types:

- **Internal Comparables** i.e. transactions between one of the parties to the controlled transaction (taxpayer or foreign associated enterprise) and an independent party.

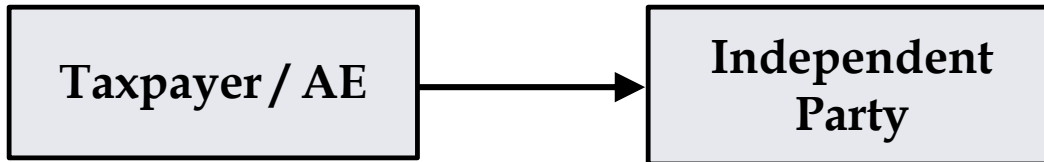

- **Third party or External Comparables** i.e. comparable uncontrolled transactions between two independent parties, neither of which is a party to the controlled transaction.

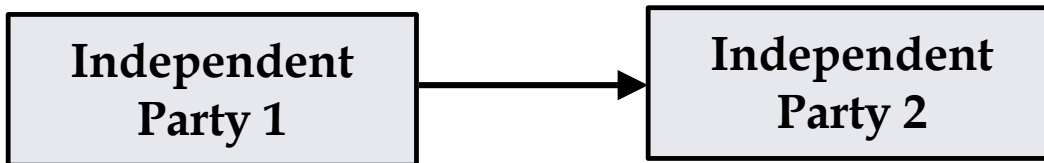

❖ Preference of Internal Comparable over External Comparable

Step 4 – Internal vs. External Comparable

❑ Internal Comparables

❖ Same level of scrutiny for internal comparables as is for external comparables.

❖ Advantages of Internal Comparables:

- More direct and closer relationship to the transaction under review
- Transaction specific info is more likely to be available
- Less expensive as no public data search is required

❖ Disadvantages of Internal Comparables:

- May not necessarily be the best evidence *if there are differences*, e.g. in transaction volumes, contractual terms, geographical markets and business strategy, which are material and cannot be eliminated through reliable comparability adjustments.

❑ External Comparables

❖ Depending upon MAM, external comparable could be transaction related data such as price or company related data such as gross/net margins

Step 5 – Search Process

□ Approaches to identifying potential comparables

❖ Additive Approach vs. Deductive Approach

- Under additive approach, list of companies believed to be potentially comparable are drawn up.
- Whereas under deductive approach, wide set of companies operating in same line of business are taken typically through a search on databases and thereafter refined by performing a quantitative or qualitative analysis.

□ **Selection of Databases under Deductive approach:**

- Indian – Capitaline, Prowess, AceTP, Prowess Pro,
- Foreign – Amadeus, Royalty Stat, Bloomberg

Step 5 – Search Process

□ Application of Quantitative & Qualitative Filters

- Financial Data
- Industry of Tested Party
- Turnover Filter
- Net worth Filter
- Related Party Transactions Filter
- Consistently Loss Making Company Filter
- Product Filter
- Functional Filter
- Ownership Filter

Step 5 – Search Process

Multi Year data – Rule 10B(5)

- ❖ From FY 2014-15,
- ❖ If method applied:
 - Resale price method;
 - Cost plus method;
 - Transactional net margin method;
- ❖ Data for analysis to be used:
 - Data for current year; or
 - Data of FY immediately preceding CY, **if the data relating to CY is not available at the time of furnishing ROI**
- ❖ Proviso: where the data relating to CY is subsequently available at the time of determination of ALP **during the course of assessment proceeding**, such data shall be used for such determination irrespective of the fact that the data was not available at the time of furnishing the return of income of the relevant assessment year

Step 6 – Comparability Adjustments

- ❖ To increase reliability of search process only
- ❖ Types of Comparability Adjustments:
 - Working Capital Adjustment
 - Fixed Asset Intensity Adjustment
 - Adjustments for accounting differences
 - Risk Adjustment
 - Adjustments for geographical factors, etc.

Step 7 – Determination of ALP

Range Concept & Multiple Year Data – Rule 10CA

- ❖ From FY 2014-15. ALP to be computed based on three PYs.
- ❖ If method applied:
 - **Comparable Uncontrolled Price Method**
 - Resale price method;
 - Cost plus method;
 - Transactional net margin method;
- ❖ **More than or equal to 6 Comparables (data points)**
- ❖ Margins between **35th & 65th Percentile** – ALP satisfied;
- ❖ Arithmetic Mean to continue to apply:
 - PSM, OM
 - CUP, CPM, RPM, TNMM and < 6 comparables
 - Tolerance band: 3% or 1% available

Case Study on Comparability Analysis



Case Study

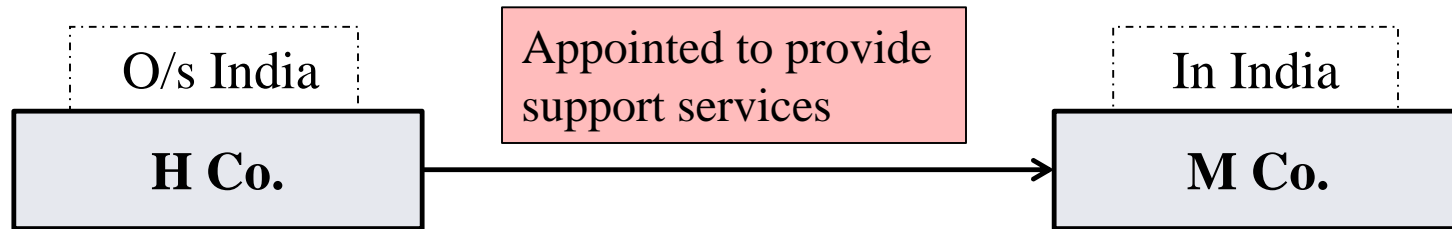

- ❖ H Co. provides full range of immigration services to Indian companies for cross border relocation.
- ❖ M Co. has been appointed to render the business support services to the H Co.
- ❖ M Co. provides all support service ancillary and supplementary to the business of H Co.
- ❖ H Co. remunerates M Co. for such support services.

Case Study - FAR

Functions Performed

Particulars	H Co.	M Co.
Planning Function	√	X
Execution Function	√	√
Marketing and Advertising	√	√
Servicing Function	√	X*
Billing and Collection	√	X
Pricing Policy	√	X
Admin Function	√	√

* M Co. provides business support service to H Co. and not directly to any third party

Assets Employed

Particulars	H Co.	M Co.
Tangible Assets	√	√
Intangible Assets	√	X

Case Study - FAR

Risks Assumed

Particulars	H Co.	M Co.
Planning and Execution	√	X
Idle capacity risk	√	X
Credit Risk	√	X
Foreign Exchange Risk	√	√*
Service Risk	√	√*

* To the extent of support services provided to H Co.

Case Study – Selection of Tested Party

Particulars	H Co.	M Co.
Least Complex Entity	X	√
Availability of Reliable and Accurate Data	X	√
Requiring Least Adjustments	X	√

- ❖ Since M Co. is:
 - least complex entity;
 - its financial data is available; and
 - would require least adjustments while computing ALP,**M Co. can be chosen as tested party.**

Case Study – Selection of MAM/ PLI

Particulars	M Co.
Comparable Uncontrolled Price Method	X
Cost Plus Method	X
Resale Price Method	X
Profit Split Method	X
Transaction Net Margin Method	√
Other Method	X

Profit Level Indicator = Operating Profit/ Operating Cost

Case Study – Search Process

Particulars	2021/03	2020/03	2019/03
Total Universe of companies in the database	XX	YY	----
Industry Classification	XX	YY	----
NIC + Segment	XX	YY	----
Financial Data for the period under consideration	XX	YY	----
Sales Turnover	XX	YY	----
Sales/ Total Income %	XX	YY	----
Net Worth	XX	YY	----
Related Party Transaction	XX	YY	----
Comparability Factors Analysis of comparables	7	7+2	7+2

Case Study - Comparability factors for Uncontrolled Entity

SR.	Name of Potential Comparable	Analysis	Result 2021/03	Result 2020/03	Result 2019/03
1	A	Software Development	NA		
2	B	Computer Programming & Consultancy	NA		
3	C	Call Centre, Back office Support Service	√	√	√
4	D	Call Centre	√	√	X
5	E	IT & ITES	X	√	√

Case Study – Determination of ALP

SR.	Name of Comparables	Weighted Average Margin
1	Comparable A	-17.68%
2	Comparable B	3.01%
3	Comparable C	3.95%
4	Comparable D	4.62%
5	Comparable E	5.55%
6	Comparable F	12.29%
7	Comparable G	19.36%

Range	Calculation	WAM
35 th Percentile	$(7*0.35) = 2.45 \sim 3^{\text{rd}}$ Position	3.95%
65 th Percentile	$(7*0.65) = 4.55 \sim 5^{\text{th}}$ Position	5.55%
Median	$(7*0.50) = 3.50 \sim 4^{\text{th}}$ Position	4.62%

Transfer Pricing Audit



Transfer Pricing Audit – Guidance Note

- ❖ **Section 92E:** Every person who has entered into an international transaction/ specified domestic transaction during a PY shall obtain a report from an accountant and furnish such report on or before the specified date in the prescribed form duly signed and verified in the prescribed manner.
- ❖ **"accountant"** means a chartered accountant as defined in section 2 of the Chartered Accountants Act, 1949 who holds a valid certificate of practice under section 6 of that Act, but does not include certain person as prescribed.
- ❖ Section 92E does not stipulate that only the statutory auditor should perform the examination. The examination can, therefore, be conducted either by the statutory auditor or by any other CA in practice.
- ❖ Accountant should communicate with the accountant who had done the examination in earlier years.
- ❖ Accountant should obtain a letter of appointment for conducting examination.
- ❖ Appointment need not be made at AGM in case of company. If BOD authorised, they can appoint.
- ❖ Joint Auditor – Principle of SA 299 to be followed.

Transfer Pricing Audit – Guidance Note

- ❖ CA who is in employment of a concern or in any other concern under the same management cannot examine the accounts under Section 92E.
- ❖ CA responsible for writing or the maintenance of the books of account of the assessee should not examine the accounts under Section 92E. Similarly internal auditor cannot do examination.
- ❖ No separate guidelines have been prescribed for fees under section 92E.
- ❖ CA is required to give his opinion as to whether the particulars are “true and correct”. True and correct means factual accuracy.
- ❖ The accountant should obtain all the books of accounts/ info/ docs/ explanation etc. to enable him to discharge his responsibility in a satisfactory manner.
- ❖ In order that the accountant may be in a position to explain any question which may arise later on, it is necessary that he should keep detailed notes about the evidence on which he has relied upon while conducting the examination and also maintain all his working papers.
- ❖ The accountant must ensure that he receives MRL in respect of all oral representations explicitly or implicitly given to him.

Transfer Pricing Audit – Guidance Note

- ❖ ‘Accounts and records’ to be examined solely in relation to ‘International Transactions’ &/or ‘Specified Domestic Transactions’ entered into by assessee during relevant PY
- ❖ Reconcile figures to be reported in 3CEB and those appearing under AS-18 disclosure
- ❖ Guidance note states TP auditor is not responsible for content of transactions and documentation maintained by the assessee.
- ❖ If proper documentation not maintained as per Rule 10D, auditor may need to qualify the report.
- ❖ Even where aggregate value of International transactions < 1 crore, assessee has to substantiate on basis of material in his possession. In these cases, auditor has to verify whether any material is available with the assessee in this regard and thereafter examine the same.

Sub - Annexure to Form 3CEB

Following are the relevant clauses for furnishing particulars **regarding International Transactions:**

Clause No	Nature of Transaction
Clause 10	List of AE
Clause 11	Tangible Property – RM / FG / FA
Clause 12	Intangible property
Clause 13	Services
Clause 14	Lending or borrowing money
Clause 15	Provision/ Receipt of Guarantee
Clause 16	Capital financing
Clause 17	Mutual Agreement/ arrangement
Clause 18	Business restructuring / reorganizations
Clause 19	Other transactions
Clause 20	Deemed international transactions

Sub - Annexure to Form 3CEB

Following are the relevant clauses for furnishing particulars regarding **Specified Domestic Transactions**:

Clause No	Nature of Transaction
Clause 21	List of AE
Clause 22	Transfer of goods/services by unit/undertaking u/s 80A(6), 80IA(8). 10AA
Clause 23	Any transaction resulting into more than ordinary profits by unit/undertaking u/s 80IA(10)/10AA
Clause 24	SDT in the nature of any business transacted between person referred to in 115BAB(6) which has resulted into more than ordinary profits
Clause 25	Any other transactions

Safe Harbour Rules



Safe Harbour – Section 92CB

- ❖ A “Safe Harbour” is defined as circumstances in which the tax authority shall accept the transfer price declared by the taxpayer.
- ❖ CBDT issued the Safe Harbour rules on 18th September 2013, applicable for five years beginning from financial year (FY) 2012-13 to FY 2016-17.
- ❖ CBDT **vide notification 46/2017 dated 7 June 2017** amended the Safe Harbour rules by extending the applicability to an additional category of international transaction as well as revising the applicable price/margins for almost all eligible international transactions that would be accepted as arm’s length.
- ❖ Safe Harbour provisions was applicable from **FY 2016-17 to FY 2018-19**. Accordingly, for FY 2016-17 (i.e. the overlapping year), option to opt for more beneficial Safe Harbour.
- ❖ **Further, CBDT had extended the applicability of Safe Harbour provisions for FY 2019-20 & FY 2020-21 from time to time.**
- ❖ **For FY 2021-22, CBDT Notification dated 17th June 2022 provided that rates applicable from FY 2016-17 to FY 2018-19 will continue to apply for FY 2021-22 as well.**

Safe Harbour Rules

Sr. No.	Eligible International Transactions	Safe Harbour Regime											
1.	Provision of Software Development Services (SDS)	<table border="1"> <tr> <th data-bbox="799 291 1224 401">International Transaction Value</th> <th data-bbox="1224 291 1754 401">Operating Profit/ Operating Expense %</th> </tr> <tr> <td data-bbox="799 401 1224 476">≤ 100 Cr</td> <td data-bbox="1224 401 1754 476">≥ 17%</td> </tr> <tr> <td data-bbox="799 476 1224 554">> 100 Cr but ≤ 200 Cr</td> <td data-bbox="1224 476 1754 554">≥ 18%</td> </tr> </table>	International Transaction Value	Operating Profit/ Operating Expense %	≤ 100 Cr	≥ 17%	> 100 Cr but ≤ 200 Cr	≥ 18%					
International Transaction Value	Operating Profit/ Operating Expense %												
≤ 100 Cr	≥ 17%												
> 100 Cr but ≤ 200 Cr	≥ 18%												
2.	Provision of Information Technology Enabled Services (ITES)	<table border="1"> <tr> <th data-bbox="799 599 1224 709">International Transaction Value</th> <th data-bbox="1224 599 1754 709">Operating Profit/ Operating Expense %</th> </tr> <tr> <td data-bbox="799 709 1224 785">≤ 100 Cr</td> <td data-bbox="1224 709 1754 785">≥ 17%</td> </tr> <tr> <td data-bbox="799 785 1224 868">> 100 Cr but ≤ 200 Cr</td> <td data-bbox="1224 785 1754 868">≥ 18%</td> </tr> </table>	International Transaction Value	Operating Profit/ Operating Expense %	≤ 100 Cr	≥ 17%	> 100 Cr but ≤ 200 Cr	≥ 18%					
International Transaction Value	Operating Profit/ Operating Expense %												
≤ 100 Cr	≥ 17%												
> 100 Cr but ≤ 200 Cr	≥ 18%												
3.	Provision of Knowledge Process Outsourcing Services (KPOs)	<table border="1"> <tr> <th colspan="2" data-bbox="799 919 1754 953">International Transaction Value should be ≤ 200 Cr</th> </tr> <tr> <th data-bbox="799 953 1224 1063">Employee Cost/ Operating Expense %</th> <th data-bbox="1224 953 1754 1063">Operating Profit/ Operating Expense %</th> </tr> <tr> <td data-bbox="799 1063 1224 1126">≥ 60%</td> <td data-bbox="1224 1063 1754 1126">≥ 24%</td> </tr> <tr> <td data-bbox="799 1126 1224 1189">≥ 40% but < 60%</td> <td data-bbox="1224 1126 1754 1189">≥ 21%</td> </tr> <tr> <td data-bbox="799 1189 1224 1252">< 40%</td> <td data-bbox="1224 1189 1754 1252">≥ 18%</td> </tr> </table>		International Transaction Value should be ≤ 200 Cr		Employee Cost/ Operating Expense %	Operating Profit/ Operating Expense %	≥ 60%	≥ 24%	≥ 40% but < 60%	≥ 21%	< 40%	≥ 18%
International Transaction Value should be ≤ 200 Cr													
Employee Cost/ Operating Expense %	Operating Profit/ Operating Expense %												
≥ 60%	≥ 24%												
≥ 40% but < 60%	≥ 21%												
< 40%	≥ 18%												

Safe Harbour Rules

Sr. No.	Eligible International Transactions	Safe Harbour Regime												
4.	Advancing of Intra-group loans in INR	<p>Benchmark rate should not be less than 1 year SBI MCLR as on 1st April of the relevant previous year plus:</p> <table border="1" data-bbox="819 446 1642 1046"> <thead> <tr> <th data-bbox="819 446 1246 554">CRISIL rating</th> <th data-bbox="1246 446 1642 554">Credit spread over Benchmark rate</th> </tr> </thead> <tbody> <tr> <td data-bbox="819 554 1246 632">AAA to A or equivalent</td> <td data-bbox="1246 554 1642 632">1.75%</td> </tr> <tr> <td data-bbox="819 632 1246 739">BBB-, BBB or BBB+ or its equivalent</td> <td data-bbox="1246 632 1642 739">3.25%</td> </tr> <tr> <td data-bbox="819 739 1246 818">BB to B or its equivalent</td> <td data-bbox="1246 739 1642 818">4.75%</td> </tr> <tr> <td data-bbox="819 818 1246 896">C to D or its equivalent</td> <td data-bbox="1246 818 1642 896">6.25%</td> </tr> <tr> <td data-bbox="819 896 1246 1046">Rating not available and amount of loan to all AEs ≤ 100 Cr</td> <td data-bbox="1246 896 1642 1046">4.25%</td> </tr> </tbody> </table>	CRISIL rating	Credit spread over Benchmark rate	AAA to A or equivalent	1.75%	BBB-, BBB or BBB+ or its equivalent	3.25%	BB to B or its equivalent	4.75%	C to D or its equivalent	6.25%	Rating not available and amount of loan to all AEs ≤ 100 Cr	4.25%
CRISIL rating	Credit spread over Benchmark rate													
AAA to A or equivalent	1.75%													
BBB-, BBB or BBB+ or its equivalent	3.25%													
BB to B or its equivalent	4.75%													
C to D or its equivalent	6.25%													
Rating not available and amount of loan to all AEs ≤ 100 Cr	4.25%													

Safe Harbour Rules

Sr. No.	Eligible International Transactions	Safe Harbour Regime												
5.	Advancing of Intra-group loans in Forex	<p>Benchmark rate should be 6-month LIBOR of relevant foreign currency as on 30th September of the relevant previous year plus:</p> <table border="1" data-bbox="819 446 1640 1046"> <thead> <tr> <th data-bbox="819 446 1246 554">CRISIL rating</th> <th data-bbox="1246 446 1640 554">Credit spread over Benchmark rate</th> </tr> </thead> <tbody> <tr> <td data-bbox="819 554 1246 632">AAA to A or equivalent</td> <td data-bbox="1246 554 1640 632">1.5%</td> </tr> <tr> <td data-bbox="819 632 1246 739">BBB-, BBB or BBB+ or its equivalent</td> <td data-bbox="1246 632 1640 739">3%</td> </tr> <tr> <td data-bbox="819 739 1246 818">BB to B or its equivalent</td> <td data-bbox="1246 739 1640 818">4.5%</td> </tr> <tr> <td data-bbox="819 818 1246 896">C to D or its equivalent</td> <td data-bbox="1246 818 1640 896">6%</td> </tr> <tr> <td data-bbox="819 896 1246 1046">Rating not available and amount of loan to all AEs ≤ INR 100 Cr</td> <td data-bbox="1246 896 1640 1046">4%</td> </tr> </tbody> </table>	CRISIL rating	Credit spread over Benchmark rate	AAA to A or equivalent	1.5%	BBB-, BBB or BBB+ or its equivalent	3%	BB to B or its equivalent	4.5%	C to D or its equivalent	6%	Rating not available and amount of loan to all AEs ≤ INR 100 Cr	4%
CRISIL rating	Credit spread over Benchmark rate													
AAA to A or equivalent	1.5%													
BBB-, BBB or BBB+ or its equivalent	3%													
BB to B or its equivalent	4.5%													
C to D or its equivalent	6%													
Rating not available and amount of loan to all AEs ≤ INR 100 Cr	4%													

Safe Harbour Rules

Sr. No.	Eligible International Transactions	Safe Harbour Regime					
6.	Providing Corporate Guarantee	Guarantee Commission/ Fee \geq 1% p.a. of the amount guaranteed					
7.	Provision of contract R&D services wholly or partly relating to software development	<table border="1"> <tr> <td data-bbox="821 414 1232 521">International Transaction Value</td> <td data-bbox="1232 414 1642 521">Operating Profit/ Operating Expense %</td> </tr> <tr> <td data-bbox="821 521 1232 596">\leq 200 Cr</td> <td data-bbox="1232 521 1642 596">\geq 24%</td> </tr> </table>	International Transaction Value	Operating Profit/ Operating Expense %	\leq 200 Cr	\geq 24%	
International Transaction Value	Operating Profit/ Operating Expense %						
\leq 200 Cr	\geq 24%						
8.	Provision of contract R&D services wholly or partly relating to generic pharmaceutical drugs	<table border="1"> <tr> <td data-bbox="821 635 1232 742">International Transaction Value</td> <td data-bbox="1232 635 1642 742">Operating Profit/ Operating Expense %</td> </tr> <tr> <td data-bbox="821 742 1232 818">\leq 200 Cr</td> <td data-bbox="1232 742 1642 818">\geq 24%</td> </tr> </table>	International Transaction Value	Operating Profit/ Operating Expense %	\leq 200 Cr	\geq 24%	
International Transaction Value	Operating Profit/ Operating Expense %						
\leq 200 Cr	\geq 24%						
9.	Manufacture and export of core auto components	Operating profit margin \geq 12%					
10.	Manufacture and export of non-core auto components	Operating profit margin \geq 8.5%					
11.	Receipt of low value-adding intra-group services	Value of International Transaction (including mark-up of \leq 5%) \leq 10 Crores <i>(Provided methods & calculations are certified by an accountant)</i>					

Secondary Adjustment



Secondary Adjustments

What

Section 92CE(1) read with 92CE(3)(v) requires secondary adjustment in the books of the taxpayer, in whose hands the primary adjustment is made, to reflect actual allocation consistent with transfer price which led to primary adjustment

When

Secondary adjustment is to be done if the primary adjustment results in **increase in total income or reduction in loss of the Assessee** either on account of :

- Suo moto adjustment in ROI
- Addition by AO accepted by taxpayer
- Determination by APA
- Determination pursuant to safe harbour rules
- Resolution under MAP methodology`

How

- **“Excess money”** available with AE to be actually repatriated to India
- If not repatriated within prescribed time limit, such “excess money” shall be deemed to be an advance by the Assessee to its AE
- Interest on such advance shall be computed in the manner as may be prescribed

Applicability

Section 92CE shall apply if:
Amount of primary adjustment in any previous year exceeds INR 1 crore;
and
Primary adjustment pertains to AY 17-18 and onwards

Secondary Adjustments

Excess money

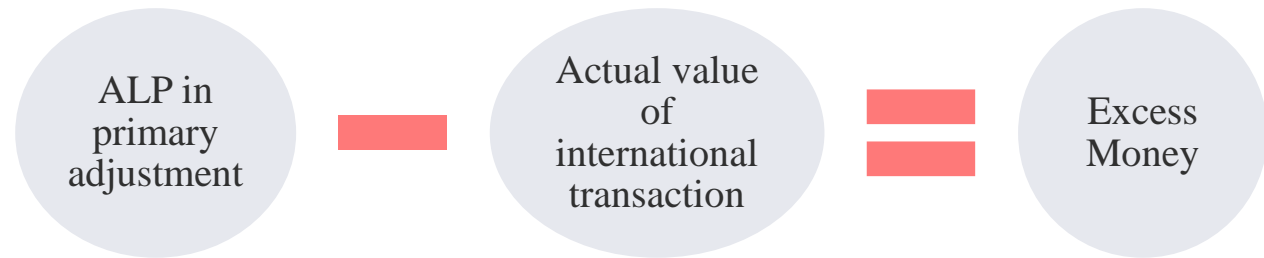

Primary Adjustment

- Transfer price
- Determined in accordance with Arms Length Principle
- Resulting in an increase in the total income of Assessee or
- Resulting in a reduction in the losses of Assessee

Secondary Adjustment

- Adjustment in books of accounts of Assessee and its AEs to reflect that the actual allocation of profits between the assessee and its AE are consistent with the transfer price determined as a result of primary adjustment, thereby removing the imbalance between cash account and actual profit of Assessee

Secondary Adjustments

- ❖ Notification No. 52/2017 dated 15 June 2017: rules for implementing secondary TP adjustment prescribing time limit for repatriation and manner of computing interest on deemed advance amount.

Type of primary adjustment	Time limit for repatriation	Applicable interest rate for delayed receipts	
		Transaction in Indian Rupee	Transaction in Foreign Currency
Adjustment made by Indian Tax Authority and accepted by the taxpayer	On or before 90 days from the date of relevant order	1-Year Marginal Cost of fund Lending Rate (MCLR) of SBI as on 1st April of relevant Financial Year (FY) (+) 325 basis points	6-Month London Interbank Offered Rate (LIBOR) as on 30th September of relevant FY (+) 300 basis points
Suo-moto adjustment by the taxpayer	On or before 90 days from due date of filing return of income		
Adjustment pursuant to APA, Safe Harbour or MAP			

Secondary Adjustments

- ❖ Section 92CE further provides that in case assessee has not repatriated excess money within the prescribed time period then assessee may pay additional income tax @ 18% on such excess money.
- ❖ The tax on the excess money so paid by the assessee shall be treated as the final payment of tax in respect of the excess money not repatriated.
- ❖ Further no credit shall be claimed by the assessee or by any other person in respect of the amount of tax so paid.
- ❖ No deduction under any other provision of this Act shall be allowed to the assessee in respect of the amount on which tax has been paid on excess money.
- ❖ In such a case assessee shall not be required to make secondary adjustment or compute interest from the date of payment of such tax.
- ❖ **Accordingly taxpayers have three broad options:**
 1. Bring in excess money within 90 days
 2. Delay in receipt of excess money + Pay interest for delay
 3. Pay tax @ 18% upon expiry of 90 days

Documentation requirements under Income Tax Act



Section 92D read with Rule 10D

- ❑ Mandatory documentation requirements in case where aggregate of **international transactions**, as recorded in the books, **exceeds Rs. 1 crore**.
- ❑ Even in cases where aggregate value of international transactions is below Rs. 1 crore, assessee is required to maintain adequate material to substantiate the arm's length nature of the transactions.
- ❑ Fresh documentation need not to be maintained separately in each previous year unless there is a significant change in nature and terms of international transaction.
- ❑ Documents to be **maintained for 8 years** from the end of the assessment year.
- ❑ **New 3 tiered approach suggested by OECD's BEPS Action Plan 13 – Master File + Local File + Country-by-Country Report**

Documents and Information to be maintained

Rule 10D	Provision	Reference to TP Documentation
(a)	Description of ownership structure	Group Overview
(b)	Profile of multinational group	
(c)	Broad description of business and industry of the assessee and AE	Group Overview and Industry Overview
(d)	Nature and terms (incl. prices) of international transactions	Economic Analysis + respective documents
(e)	FAR analysis	FAR Analysis
(f)	Record of economic and market analyses, forecasts, budgets etc.	Respective documents in separate files

Documents and Information to be maintained

Rule 10D	Provision	Reference to TP Documentation
(g)	Record of uncontrolled transactions	Economic Analysis + relevant appendices
(h)	Evaluating comparability of uncontrolled transaction with relevant international or domestic transaction	
(i)	Description of methods considered and selection of most appropriate method	
(j)	Relevant working for determining arm's length price	
(k)	Factors affecting determination of arm's length price	Respective documents in separate files (if any)
(l)	Details of adjustments	
(m)	Any other relevant information for determination of arm's length price	

CbCR – Sec. 286

- ❖ Finance Act 2016 inserted Section 286 relating to filing of CbCR
- ❖ **Parent entity** means a constituent entity, of an international group holding, directly or indirectly, an interest in one or more of the other constituent entities of the international group such that –
 - It is required to prepare a **consolidated financial statement** under any law for the time being in force or the accounting standards of the country or territory in which the entity is resident; or
 - It would have been required to prepare a consolidated financial statement had the equity shares of any of the enterprises were listed on a stock exchange
- ❖ **Constituent entity** means –
 - Any separate entity of an international group that is included in the consolidated financial statement of the said group.
 - Any such entity that is excluded from the consolidated financial statement solely on the basis of size or materiality.
 - Any permanent establishment of any separate business entity.

Master File- Rule 10DA

❑ Constituent Entity to file if:

➤ Consolidated Revenue of the International Group in Preceding accounting year > INR 500 crores

AND

➤ Aggregate value of International Transaction in Reporting Year As per Books of Accounts > INR 50 crores **OR** Aggregate value of International Transaction in Reporting Year in relation to Intangible property > INR 10 crores

❖ MasterFile Forms and Timelines

Particulars	Form	Timelines
Every constituent entity of an international group	Form 3CEAA (Part A)	On or before filing due date of return of income
Constituent entity of the international group satisfying the above threshold	Form 3CEAA (Part A & B)	On or before filing due date of return of income
Multiple constituent group entities in India (Intimation)	Form 3CEAB	30 days prior to filing return of income

Master File- Rule 10DA

Constituent entity should keep and maintain the following information:

- List of all the entities of the group
- Organisation structure – legal & ownership along with location
- **General description** of business including
 - Important **drivers of business profit**
 - Description of **supply chain** for + 5 pdts / >5% of consolidated group revenue
 - Important **intra group services**
 - Description of main service provider within the group
 - TP policy for allocation of cost and determination of price to paid
 - **Main geographies** of product/services offered
 - **FAR of all the CEs** that contribute > 10% revenue/assets/profit of the group
 - Important **business restructuring** transactions
- Groups overall strategy for the development of **intangible**
- List of all the entities of the group engaged in development/management of **intangible** property along with their address
- List of important **intangibles** & name of entity within group who owns it
- Important agreement related to **intangibles** such as CCA, R&D service / license agmt
- TP policy related to R&D and **intangibles**
- Important transfers of **intangibles**
- Description of **financing arrangements** including name & address of top 10 unrelated lender
- List of group entities that provide **central financing functions** & their POEM
- TP policy related to **financing functions**
- Consolidated financial statements
- Existing unilateral APAs and other rulings relating to allocation of income

Country by Country Reporting (CbCR) - Rule 10DB

❖ CbCR Applicability

Particulars	Threshold	Data to be considered
Consolidated Revenue of International Group	INR 6400 Crore	Preceding Accounting Year

❖ CbCR Forms and Timelines

Particulars	Form	Timelines
Intimation by Indian resident constituent entity : details of parent entity / alternate reporting entity which will file CbCR	Form 3CEAC	2 Months prior to filing CbCR
Filing CbCR - Every parent entity or the alternate reporting entity resident in India (where parent is resident of country having no EOI for CbCR with India)	Form 3CEAD	Within 12 months from the end of reporting accounting year
Intimation of Multiple constituent group entities in India	Form 3CEAE	2 Months prior to filing CbCR

Country by Country Reporting (CbCR) - Rule 10DB

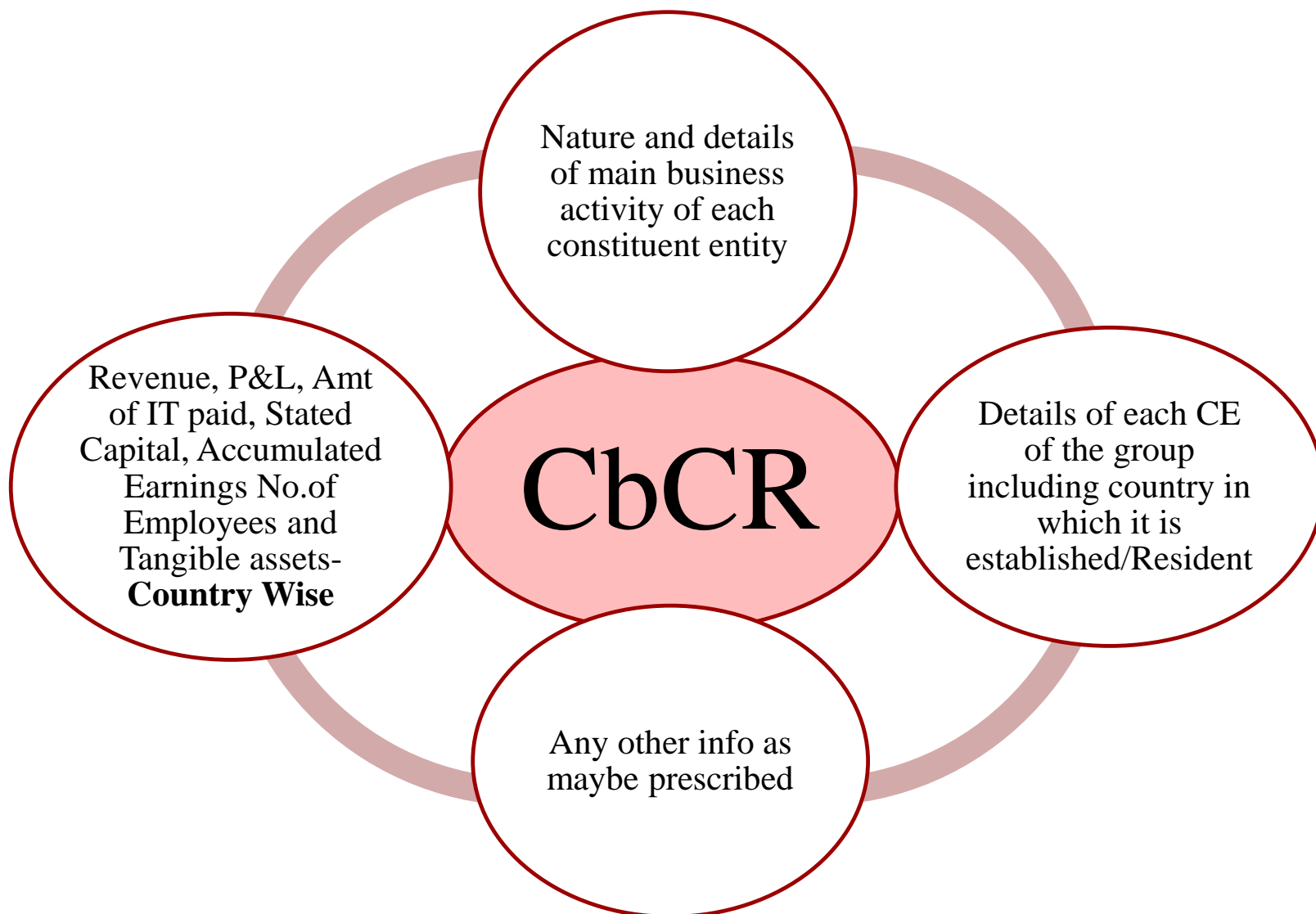

Advance Pricing Agreement (APA)



Dispute Resolution Mechanism

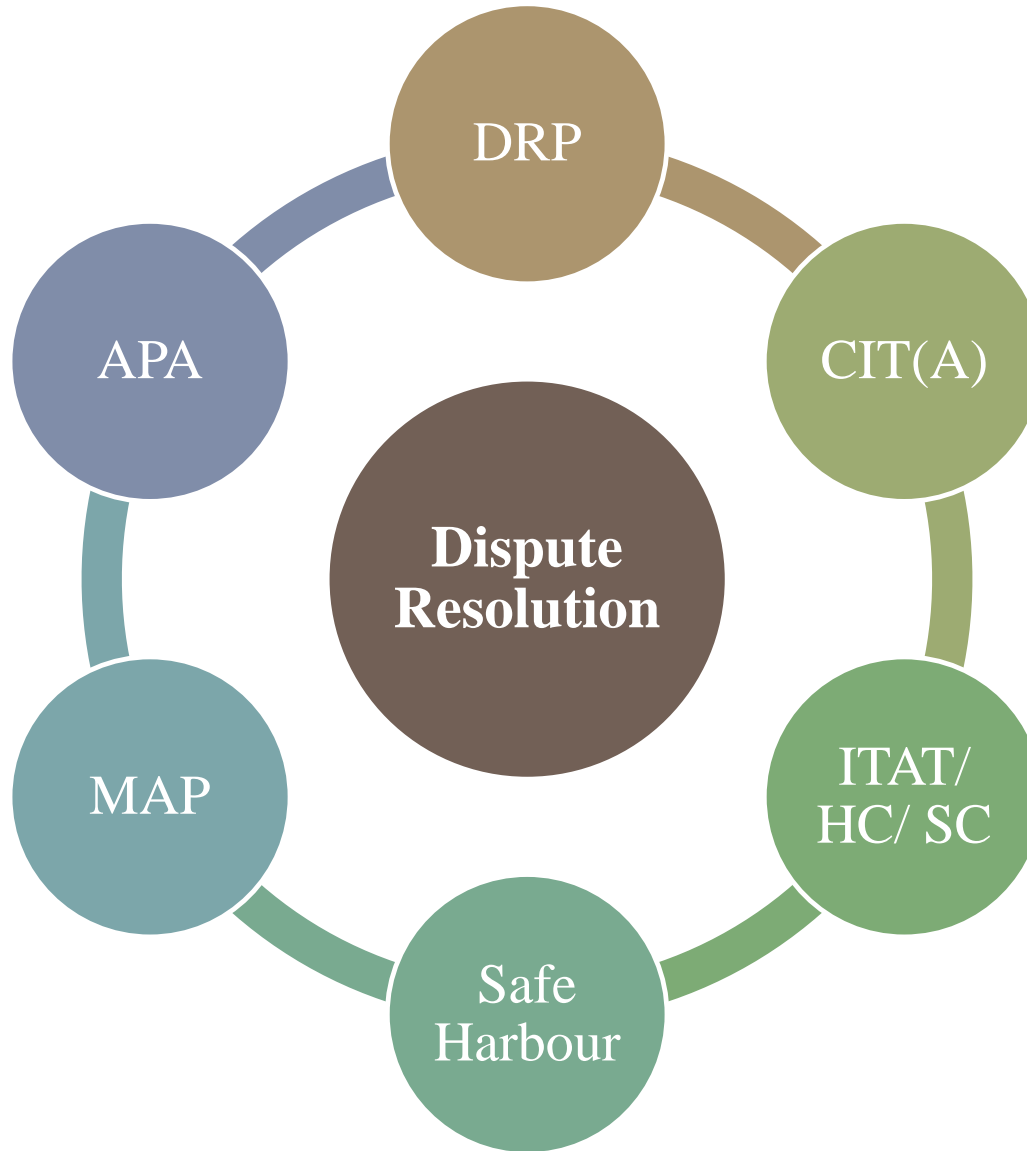

What is Advance Pricing Agreement?

- ❖ Advance Pricing Agreement ('APA') provisions were introduced in the Income-tax Act w.e.f. 1 July 2012. The rules in respect of the APA scheme have been notified by way of insertion of Rule 10F to Rule 10T and Rule 44GA in the Income-tax Rules, 1962.
- ❖ APA is an agreement between a tax payer and tax authority determining the transfer pricing methodology for setting up transfer price for the tax payer's international transactions for future years.
- ❖ The methodology is to be applied for a certain period of time based on the fulfillment of certain terms and conditions called critical assumptions.
- ❖ Critical assumptions means the factors and assumptions that are so critical and significant that neither party entering into an agreement will continue to be bound by the agreement, if any of the factors or assumptions is changed.
- ❖ Any person who has undertaken an international transaction or is contemplating to undertake an international transaction can apply for APA filing. [w.e.f. 01/04/20, APA also applicable for determination of profit attribution of NR in India]
- ❖ APA valid for period specified – Max 5 consecutive years.
- ❖ Rollback provision for prior 4 years.

Types of Advance Pricing Agreement

Unilateral APA

- APA that involves tax payer & tax authority of country of taxpayer

Bilateral APA

- APA that involves taxpayer, AE of taxpayer, tax authority of country of taxpayer as well as of AE

Multilateral APA

- APA that involves taxpayer, 2 or more AEs of taxpayer, tax authority of country of taxpayer as well as of AEs

Benefits & Scope of APA

❖ Benefits of APA:

- Certainty with respect to international transaction of taxpayer
- Avoids TP Litigation
- TP Documents relief for APA period
- Solution to complex transfer pricing issues
- Reduction of TP compliance cost
- For tax authority, reduced cost of administration
- Reduce potential risk of double taxation

❖ Scope of APA: An APA among other thing includes:

- International transaction covered by the agreement
- Agreed TP methodology
- Determination of ALP
- Definition of relevant term
- Rollback provision
- Critical assumption & other conditions

Rollback of the Agreement

- ❖ The Finance (No.2) Act, 2014 introduced the rollback provision under the APA programme.
- ❖ Option for taxpayer to rollback terms of APA for previous 4 years preceding the first year covered in the APA.
- ❖ Condition to be fulfilled:
 - International transaction same as covered in APA
 - Return of income for rollback years furnished before due date
 - Report in respect of international transaction has been furnished u/s 92E
 - Request for rollback for all years
 - Application in 3CEDA
- ❖ Rollback shall not be provided if:
 - Determination of ALP for such year has been subject matter of appeal and AT has passed the order on the same
 - It has effect of reducing total income or increasing the loss

Typical APA Process

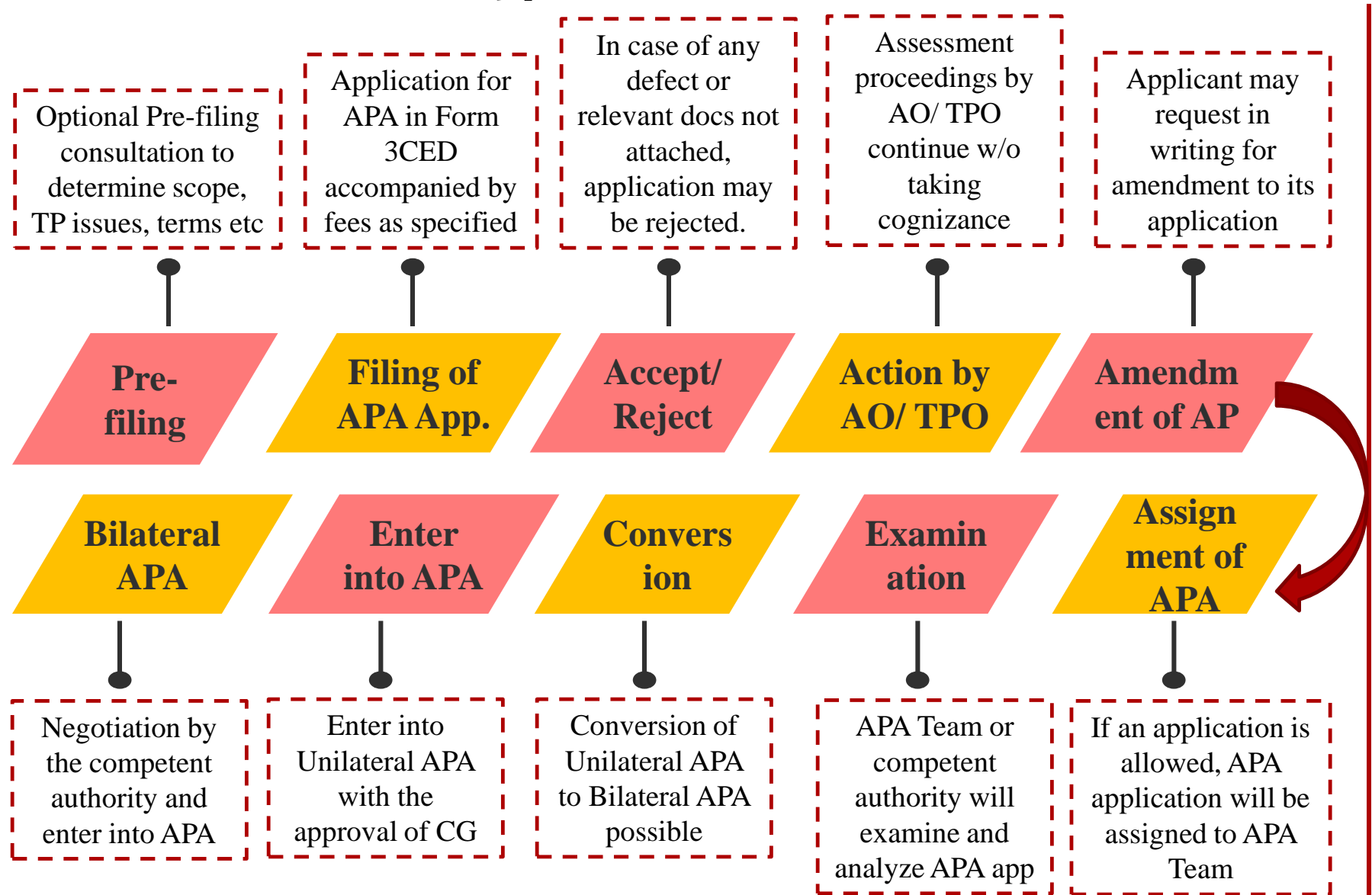

Revision/ Cancellation/ Renewal of APA

Revision of APA

- Rule 10Q
- May be revised if there is change:
 - Critical assumption
 - Law
 - Request from competent authority of foreign country in case of bilateral/ unilateral APA

Cancellation of APA

- Rule 10R
- Shall be cancelled if:
 - Failed to file annual compliance
 - Annual compliance filed contains material error
 - Taxpayer failed to comply with terms of APA

Renewal of APA

- Rule 10S
- Request for renewal as new application
- Pre-filing not required

Transfer Pricing Assessment



Building Blocks for TP Assessment

Assessment Units – Section 144B(3)(iii)

- Functions of assessment including identification of material issues/ seeking info or clarification/ analysis of the material furnished

Verification Units – Section 144B(3)(iv)

- Function of verification including enquiry/ cross verification/ examination of books of account & witness/ recording of statements etc.

Technical Units – Section 144B(3)(v)

- Function of technical assistance such as advice on legal, accounting, forensic, information technology, valuation, **transfer pricing**, data analytics, management or any other technical matter

Review Units – Section 144B(3)(vi)

- Function of reviewing draft assessment order/ check docs on record/ relevant point of law incorporated/ issue addition or disallowance

Dispute Resolution Panel – Section 144C

- To facilitate expeditious resolution of disputes, DRP has been constituted

Faceless Assessment Procedure w.e.f. AY 21-22– Simplistic Overview

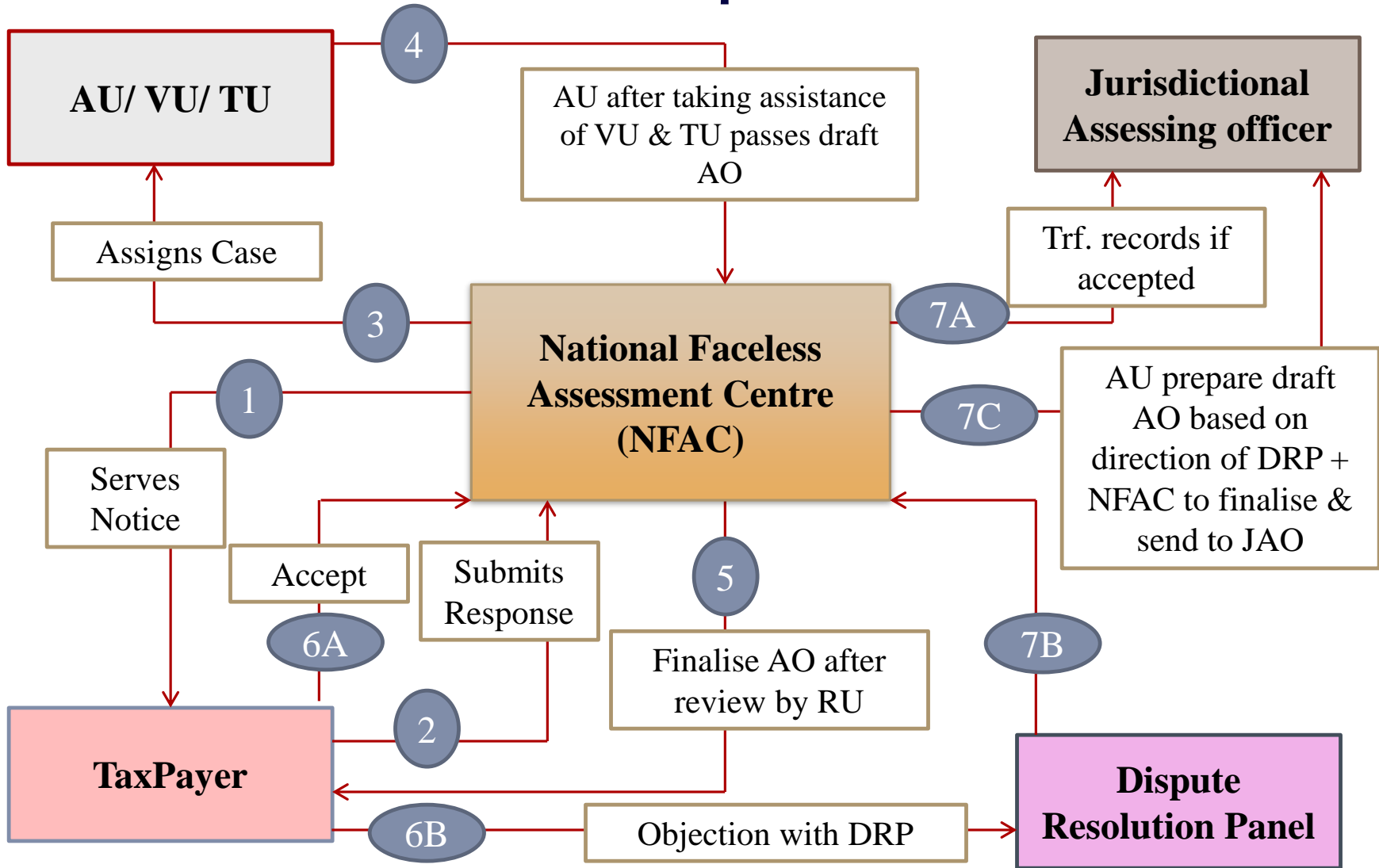

Sincere Acknowledgement:

Naisar Shah

Thank you

